

НАРУЖНОЕ ФУНКЦИОНАЛЬНОЕ ОСВЕЩЕНИЕ

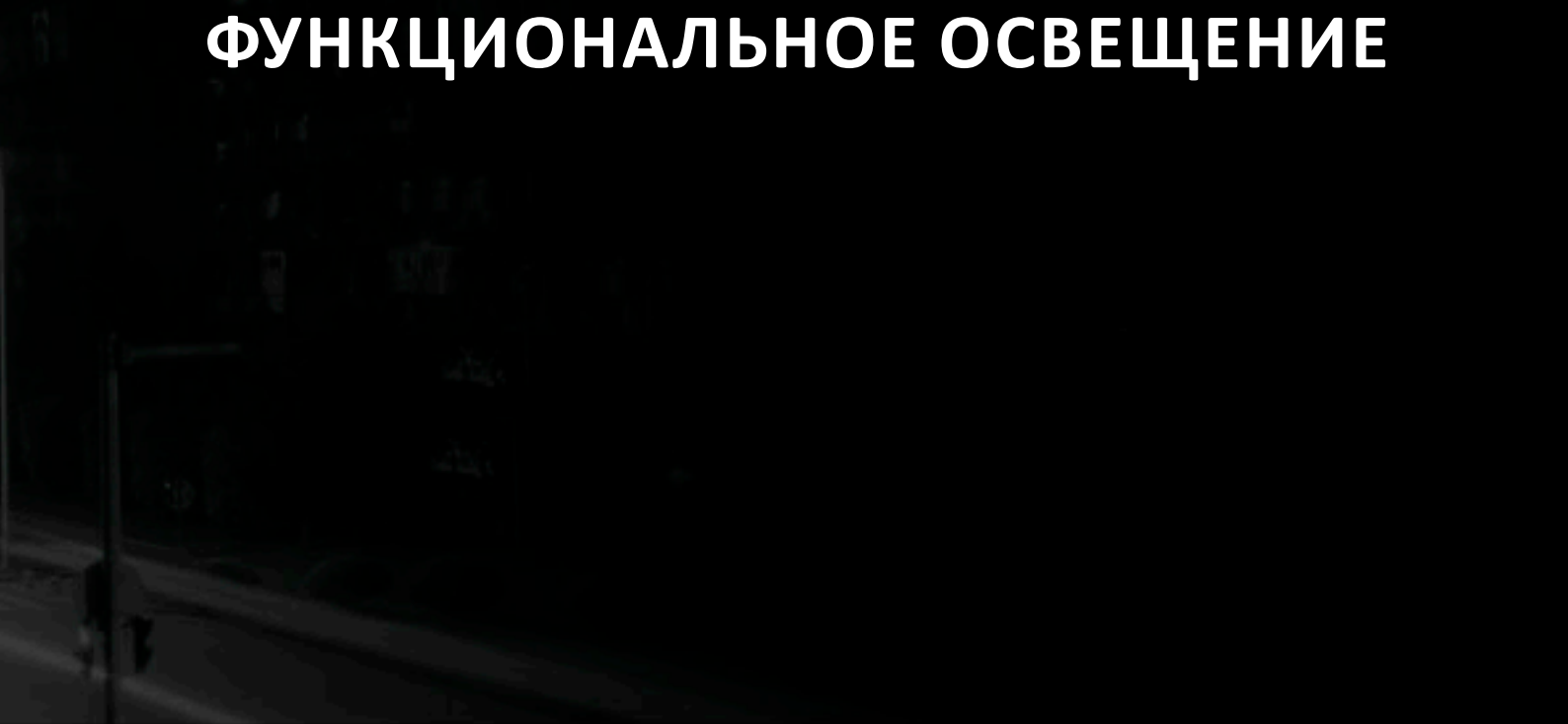

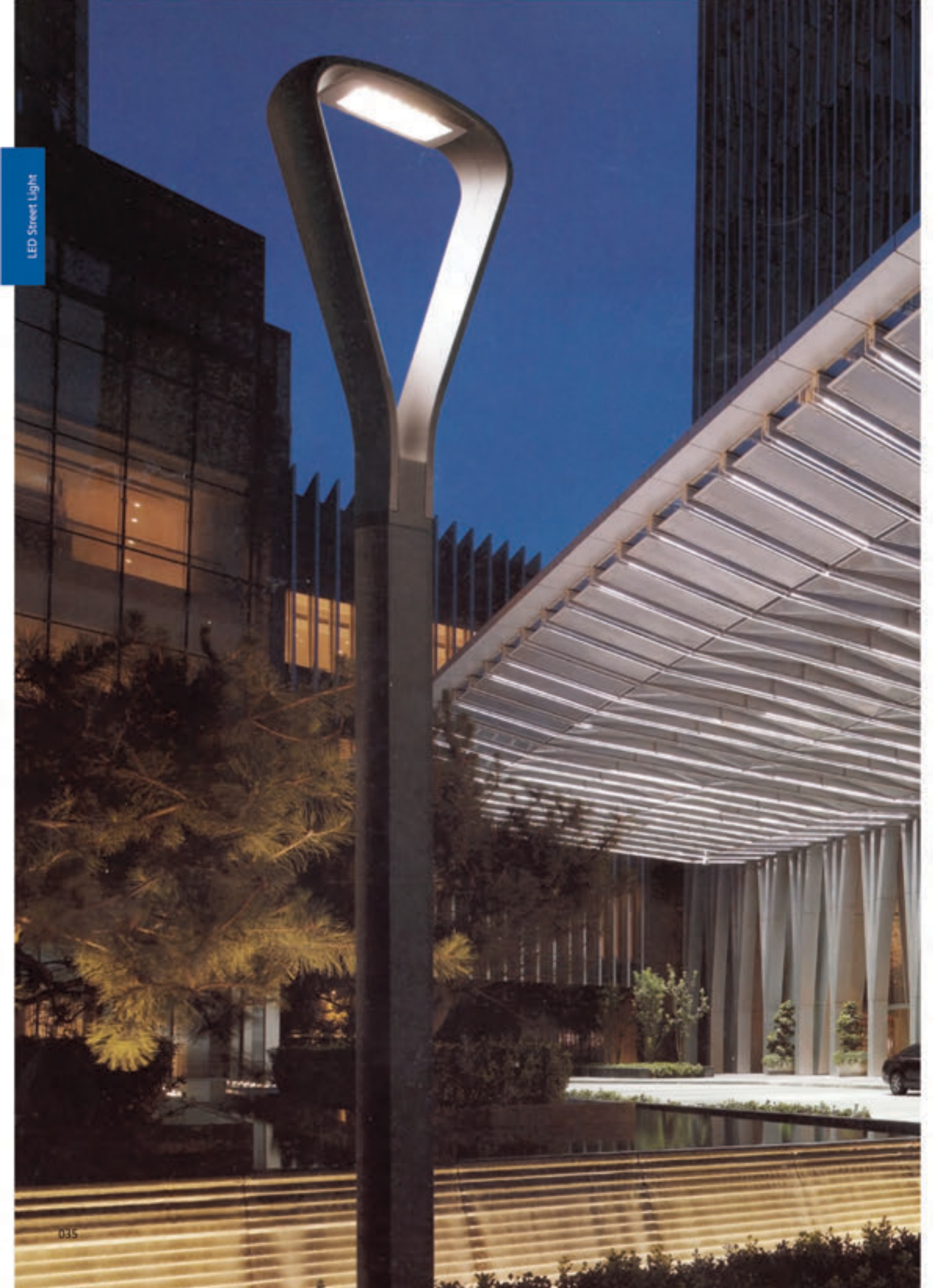

OLO-DH-16026

Description

Body: Cast aluminum body, aluminum extruded column.
Optical system: Anodized PP plastic reflector and special light distribution lens, super white tempered glass.
Finishing: Surface anti-aging painting processing, super resistance to corrosion.
Assembling height: 3.5-5m.

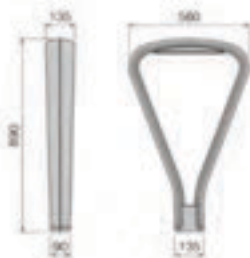

Technology Data

Code	Lamp	Output power	Packing box size(mm)
OLO-DH-151LED60-16	LED	60W	920x560x170
OLO-DH-151LED80-16		80W	



OLO-DHL-16025

Description

- Body: Cast aluminum top cover, aluminum extruded column.
- Optical system: Anodized aluminum grid, transparent PMMA diffuser.
- Finishing: Surface anti-ageing painting processing, super resistance to corrosion.

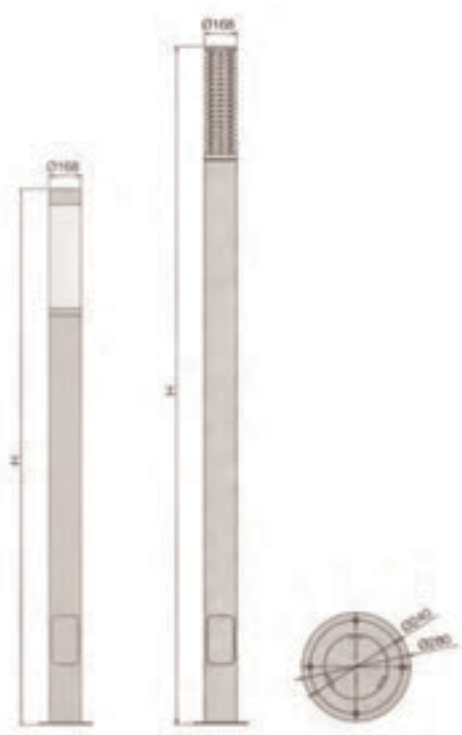

OLO-DHL-16027 OLO-DHL-16026

Technology Data

Code	Lamp	Output power	LED Pcs	Size(mm)
OLO-DHL-16025	Fluorescent	55W	/	Ø170x240x2700
OLO-DHL-16026		55W	/	Ø170x240x3500
OLO-DHL-16027	LED	50W	1xCOB 90-260 50/60Hz	Ø170x240x2700
OLO-DHL-16028		50W	1xCOB 90-260 50/60Hz	Ø170x240x3500



OLO-DHL-16023

Input Voltage: AC 90-260V

Power: LED45W/60W

Frequency Range: 50/60Hz

Material: Aluminum

Protection Grade: IP65

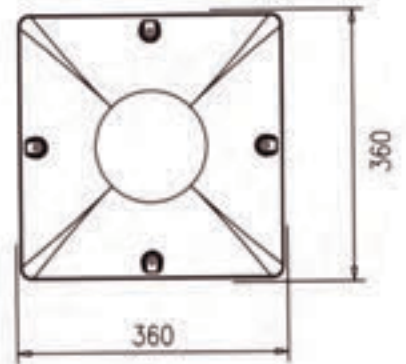
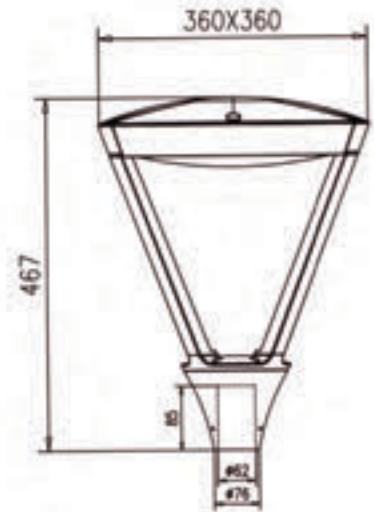

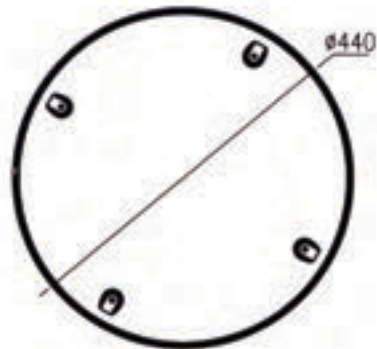
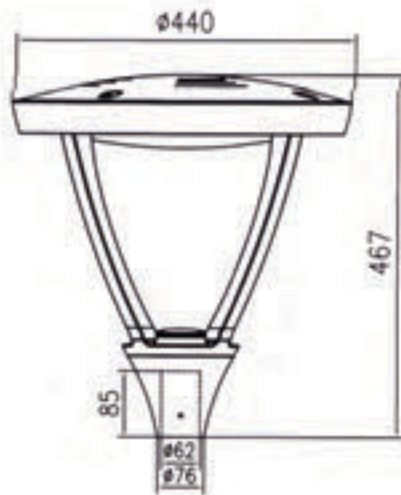

OLO-DHL-16024

Input Voltage: AC 90-260V

Power: LED45W/60W

Frequency Range: 50/60Hz

Material: Aluminum

Protection Grade: IP65





- Cast aluminum head
- Steel pole

Stainless steel screws, Silicon seal gaskets

COLOR TEMPERATURE
3000/6000K

FINISH
Texture dark gray or silver powdercoat finish

PROTECTION CLASS
IP 65

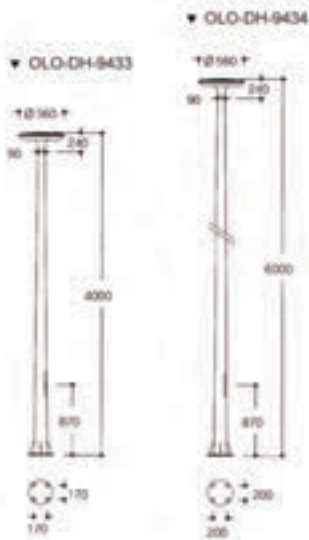

	LAMP
OLO-DH-9433	LED 75W 90-260V 50/60Hz
OLO-DH-9434	LED 100W 90-260V 50/60Hz



OLO-DH-9427

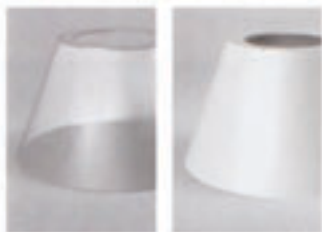

HOUSING

Cast aluminum head, Steel pole, Stainless steel screws
Silicon seal gaskets

COLOR TEMPERATURE

3000K / 6000K

FINISH

Texture dark gray or silver powdercoat finish

PROTECTION CLASS

IP 65

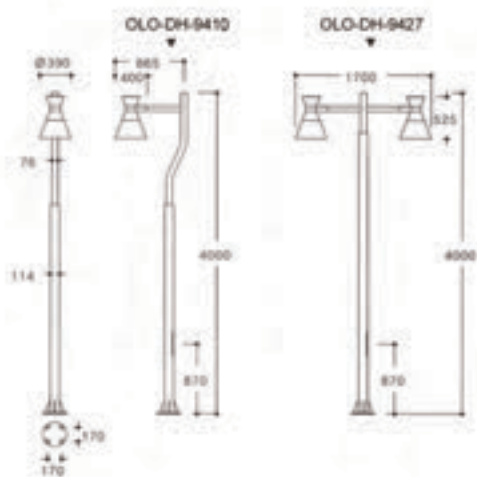

LAMP

OLO-DH-9410	LED	60W	90-260V	50/60Hz
OLO-DH-9427	LED	60Wx2	90-260V	50/60Hz

OLO-DH-9410



HOUSING

Cast and extruded aluminum
Stainless steel screws, Silicon seal gaskets

DIFFUSER

Opal and clear polycarbonate

COLOR TEMPERATURE

3000/6000K

FINISH

Texture dark gray or silver powdercoat finish

PROTECTION CLASS

IP 54



LAMP

OLO-DH-9210 LED 80W 90-260V 50/60Hz



OLO-DHL-16021

PRODUCT DESCRIPTION:

- Body: Made of high quality cast aluminum alloy with treatment of corrosion protection and UV-proof powder coating.
- Diffuser: Clear glass/PC
- Reflector: Made of anodized high pure aluminum.
- Gasketing: Made of thermostable silica gel to improve protection class.
- Fastener: Made of stainless steel with high intensity and corrosion protection.

TECHNICAL DATA:

- Protection Class: IP65
- Application: Urban streets , Parks,Squares,Gardens,Hotels,Villas and so on.
- Lamp: LED 10/20W
- Finish: Matt grey as standard.Dark grey ,Matt coffee, Dark bronze, Matt black any other RAL color is available upon request.







HOUSING

Diecast aluminum head, Steel pole
Stainless steel screws, Silicon seal gaskets

DIFFUSER

Opal acrylic

COLOR TEMPERATURE

3000/6000K

FINISH

Texture dark gray or silver powdercoat finish

PROTECTION CLASS

IP 65

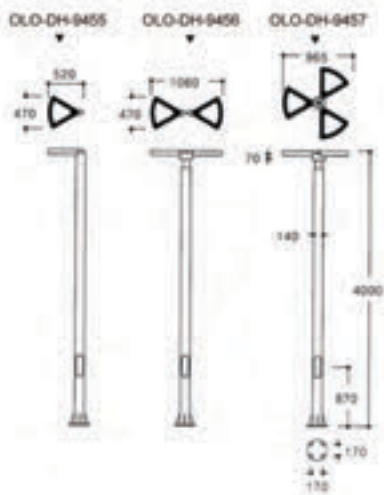

LAMP

OLO-DH-9455	LED 50Wx1 90-260V 50/Hz
OLO-DH-9456	LED 50Wx2 90-260V 50/Hz
OLO-DH-9457	LED 50Wx3 90-260V 50/Hz



OLO-DHL-16020

PRODUCT DESCRIPTION:

- Body: Made of high quality cast aluminum alloy with treatment of corrosion protection and UV-proof powder coating.
- Diffuser: Clear glass
- Reflector: Made of anodized high pure aluminum.
- Gasketing: Made of thermostable silica gel to improve protection class.
- Fastener: Made of stainless steel with high intensity and corrosion protection.

TECHNICAL DATA:

- Protection Class: IP65
- Application: Urban streets , Parks,Squares,Gardens,Hotels,Villas and so on.
- Lamp: LED COB 20-40Wx1
- Finish: Matt black as standard,Dark grey,Matt grey, Dark bronze, Matt coffee any other RAL color is available upon request.



LED Street Light

OLO-DHL-16020



OLO-DHL-16001

OLO-DHL-16001

PRODUCT DESCRIPTION:

- Body: Made of high quality cast aluminum alloy with treatment of corrosion protection and UV-proof powder coating.
- Diffuser: Clear polycarbonate
- Reflector: Made of anodized high pure aluminum.
- Gasketing: Made of thermostable silica gel to improve protection class.
- Fastener: Made of stainless steel with high intensity and corrosion protection.

TECHNICAL DATA:

- Protection Class: IP65
- Application: Urban streets , Parks,Squares,Gardens,Hotels,Villas and so on.
- Lamp: LED COB 20Wx1
- Finish: Dark grey as standard.Matt coffee,Matt grey,Dark bronze, Matt black any other RAL color is available upon request.



OLO-DHL-16002

PRODUCT DESCRIPTION:

- Body: Made of high quality cast aluminum alloy with treatment of corrosion protection and UV-proof powder coating.
- Diffuser: Opal polycarbonate
- Reflector: Made of anodized high pure aluminum.
- Gasketing: Made of thermostable silica gel to improve protection class.
- Fastener: Made of stainless steel with high intensity and corrosion protection.

TECHNICAL DATA:

- Protection Class: IP65
- Application: Urban streets , Parks,Squares,Gardens,Hotels,Villas and so on.
- Lamp: LED COB 50Wx1
- Finish: Dark grey as standard.Matt coffee,Matt grey,Dark bronze, Matt black any other RAL color is available upon request.

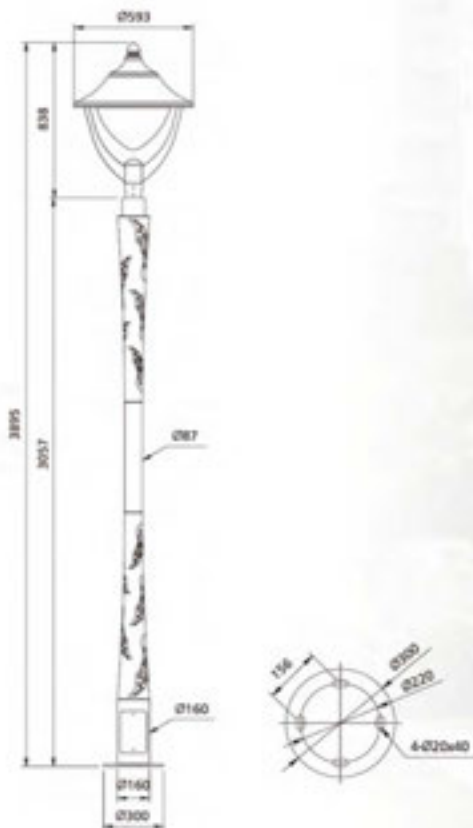

LED Street Light

OLO-DHL-16002

OLO-DHL-15003

PRODUCT DESCRIPTION:

- Body: Made of high quality cast aluminum alloy with treatment of corrosion protection and UV-proof powder coating.
- Diffuser: Clear glass
- Reflector: Made of anodized high pure aluminum.
- Gasketing: Made of thermostable silica gel to improve protection class.
- Fastener: Made of stainless steel with high intensity and corrosion protection.

TECHNICAL DATA:

- Protection Class: IP65
- Application: Urban streets , Parks,Squares,Gardens,Hotels,Villas and so on.
- Lamp: LED COB 30-50Wx2
- Finish: Dark grey and Matt grey as standard.Matt coffee, Dark bronze, Matt black any other RAL color is available upon request.

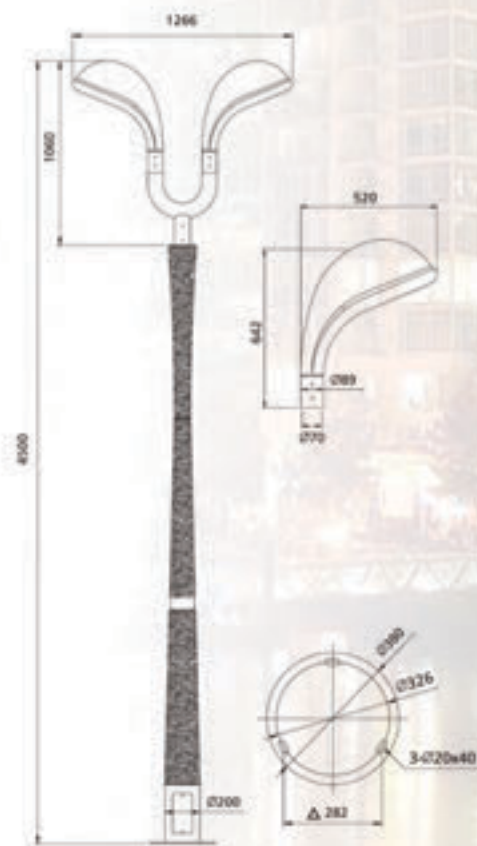

OLO-DHL-15003



OLO-DHL-15004

PRODUCT DESCRIPTION:

- Body: Pole is made of high quality steel with hot-dipped galvanization inside and outside while luminaire is made of die-cast aluminum with treatment of corrosion protection and UV-proof powder coating.
- Diffuser: Clear glass, Yellow polycarbonate
- Reflector: Made of anodized high pure aluminum.
- Gasketing: Made of thermostable silica gel to improve protection class.
- Fastener: Made of stainless steel with high intensity and corrosion protection.

TECHNICAL DATA:

- Protection Class: IP65
- Application: Urban streets, Parks, Squares, Gardens, Hotels, Villas and so on.
- Lamp: LED COB 20-50Wx3+3Wx3
- Finish: Dark grey and yellow as standard. Matt coffee, Matt grey, Dark bronze, Matt black any other RAL color is available upon request.

OLO-DHL-15004



OLO-DHL-15005

PRODUCT DESCRIPTION:

- Body: Pole is made of high quality steel with hot-dipped galvanization inside and outside while luminaire is made of die-cast aluminum with treatment of corrosion protection and UV-proof powder coating.
- Diffuser: Clear glass, Yellow polycarbonate
- Reflector: Made of anodized high pure aluminum.
- Gasketing: Made of thermostable silica gel to improve protection class.
- Fastener: Made of stainless steel with high intensity and corrosion protection.

TECHNICAL DATA:

- Protection Class: IP65
- Application: Urban streets, Parks, Squares, Gardens, Hotels, Villas and so on.
- Lamp: LED COB 20-50Wx6+3Wx6
- Finish: Dark grey and yellow as standard. Matt coffee, Matt grey, Dark bronze, Matt black any other RAL color is available upon request.



OLO-DHL-15005



OLO-DHL-15006



OLO-DHL-15006

PRODUCT DESCRIPTION:

- Body: Made of high quality cast aluminum alloy with treatment of corrosion protection and UV-proof powder coating.
- Diffuser: Clear glass
- Reflector: Made of anodized high pure aluminum.
- Gasketing: Made of thermostable silica gel to improve protection class.
- Fastener: Made of stainless steel with high intensity and corrosion protection.

TECHNICAL DATA:

- Protection Class: IP65
- Application: Urban streets , Parks,Squares,Gardens,Hotels,Villas and so on.
- Lamp: LED COB 20-50Wx1
- Finish: Matt grey as standard.Dark grey ,Matt coffee, Dark bronze, Matt black any other RAL color is available upon request.



OLO-DHL-15007

PRODUCT DESCRIPTION:

- Body: Made of high quality cast aluminum alloy with treatment of corrosion protection and UV-proof powder coating.
- Diffuser: Clear glass
- Reflector: Made of anodized high pure aluminum.
- Gasketing: Made of thermostable silica gel to improve protection class.
- Fastener: Made of stainless steel with high intensity and corrosion protection.

TECHNICAL DATA:

- Protection Class: IP65
- Application: Urban streets , Parks,Squares,Gardens,Hotels,Villas and so on.
- Lamp: LED COB 20-50Wx2
- Finish: Matt black as standard. Dark grey, Matt coffee, Dark bronze, Matt grey any other RAL color is available upon request.



OLO-DHL-15007

OLO-DHL-15008**PRODUCT DESCRIPTION:**

- Body: Made of high quality cast aluminum alloy with treatment of corrosion protection and UV-proof powder coating.
- Diffuser: Clear glass
- Reflector: Made of anodized high pure aluminum.
- Gasketing: Made of thermostable silica gel to improve protection class.
- Fastener: Made of stainless steel with high intensity and corrosion protection.

TECHNICAL DATA:

- Protection Class: IP65
- Application: Urban streets , Parks,Squares,Gardens,Hotels,Villas and so on.
- Lamp: LED COB 20-50Wx3
- Finish: Dark grey as standard.Matt black, Matt coffee, Dark bronze, Matt grey any other RAL color is available upon request.

**OLO-DHL-15008**



OLO-DHL-15009

PRODUCT DESCRIPTION:

- Body: Made of high quality cast aluminum alloy with treatment of corrosion protection and UV-proof powder coating.
- Diffuser: Clear glass
- Reflector: Made of anodized high pure aluminum.
- Gasketing: Made of thermostable silica gel to improve protection class.
- Fastener: Made of stainless steel with high intensity and corrosion protection.

TECHNICAL DATA:

- Protection Class: IP65
- Application: Urban streets , Parks,Squares,Gardens,Hotels,Villas and so on.
- Lamp: LED COB 20-50Wx1
- Finish: Matt grey as standard.Dark grey, Matt coffee, Dark bronze, Matt black any other RAL color is available upon request.



OLO-DHL-15009



OLO-DHL-15010



OLO-DHL-15010

PRODUCT DESCRIPTION:

- Body: Made of high quality cast aluminum alloy with treatment of corrosion protection and UV-proof powder coating.
- Diffuser: Clear glass
- Reflector: Made of anodized high pure aluminum.
- Gasketing: Made of thermostable silica gel to improve protection class.
- Fastener: Made of stainless steel with high intensity and corrosion protection.

TECHNICAL DATA:

- Protection Class: IP65
- Application: Urban streets , Parks,Squares,Gardens,Hotels,Villas and so on.
- Lamp: LED COB 20-50Wx2
- Finish: Matt black as standard. Dark grey, Matt coffee, Dark bronze, Matt grey any other RAL color is available upon request.

OLO-DHL-15011

PRODUCT DESCRIPTION:

- Body: Made of high quality cast aluminum alloy with treatment of corrosion protection and UV-proof powder coating.
- Diffuser: Clear glass
- Reflector: Made of anodized high pure aluminum.
- Gasketing: Made of thermostable silica gel to improve protection class.
- Fastener: Made of stainless steel with high intensity and corrosion protection.

TECHNICAL DATA:

- Protection Class: IP65
- Application: Urban streets , Parks,Squares,Gardens,Hotels,Villas and so on.
- Lamp: LED COB 20-50Wx3
- Finish: Dark grey as standard.Matt black, Matt coffee, Dark bronze, Matt grey any other RAL color is available upon request.



OLO-DHL-15011



OLO-DHL-16004

OLO-DHL-16004

PRODUCT DESCRIPTION:

- Body: Made of high quality cast aluminum and iron alloy with treatment of corrosion protection and UV-proof powder coating.
- Diffuser: Clear glass
- Reflector: Made of anodized high pure aluminum.
- Gasketing: Made of thermostable silica gel to improve protection class.
- Fastener: Made of stainless steel with high intensity and corrosion protection.

TECHNICAL DATA:

- Protection Class: IP65
- Application: Urban streets , Parks,Squares,Gardens,Hotels,Villas and so on.
- Lamp: LED COB 20Wx3
- Finish: Matt black as standard.Dark grey,Matt grey, Dark bronze,Matt coffee any other RAL color is available upon request.



OLO-DHL-16005

PRODUCT DESCRIPTION:

- Body: Made of high quality cast aluminum and iron alloy with treatment of corrosion protection and UV-proof powder coating.
- Diffuser: Clear glass
- Reflector: Made of anodized high pure aluminum.
- Gasketing: Made of thermostable silica gel to improve protection class.
- Fastener: Made of stainless steel with high intensity and corrosion protection.

TECHNICAL DATA:

- Protection Class: IP65
- Application: Urban streets , Parks,Squares,Gardens,Hotels,Villas and so on.
- Lamp: LED COB 20Wx6
- Finish: Matt black as standard.Dark grey,Matt grey, Dark bronze, Matt coffee any other RAL color is available upon request.



OLO-DHL-16005



OLO-DHL-16006

OLO-DHL-16006

PRODUCT DESCRIPTION:

- Body: Made of high quality cast aluminum and iron alloy with treatment of corrosion protection and UV-proof powder coating.
- Diffuser: Frosted polycarbonate
- Reflector: Made of anodized high pure aluminum.
- Gasketing: Made of thermostable silica gel to improve protection class.
- Fastener: Made of stainless steel with high intensity and corrosion protection.

TECHNICAL DATA:

- Protection Class: IP65
- Application: Urban streets, Parks, Squares, Gardens, Hotels, Villas and so on.
- Lamp: LED COB 50Wx1
- Finish: Matt coffee as standard. Dark grey, Matt grey, Dark bronze, Matt black any other RAL color is available upon request.

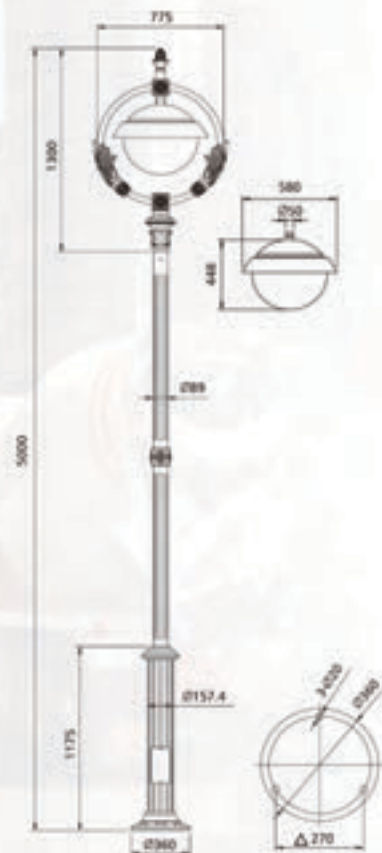

OLO-DHL-16007

PRODUCT DESCRIPTION:

- Body: Made of high quality cast aluminum and iron alloy with treatment of corrosion protection and UV-proof powder coating.
- Diffuser: Frosted polycarbonate
- Reflector: Made of anodized high pure aluminum.
- Gasketing: Made of thermostable silica gel to improve protection class.
- Fastener: Made of stainless steel with high intensity and corrosion protection.

TECHNICAL DATA:

- Protection Class: IP65
- Application: Urban streets , Parks,Squares,Gardens,Hotels,Villas and so on.
- Lamp: LED COB 50Wx1
- Finish: Matt coffee as standard,Dark grey,Matt grey, Dark bronze, Matt black any other RAL color is available upon request.

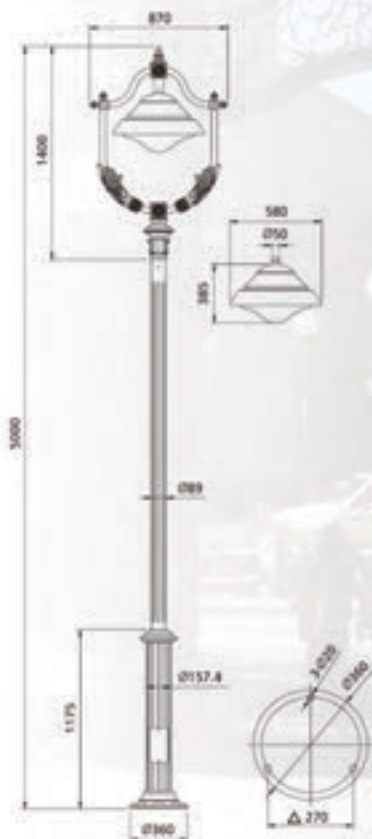

OLO-DHL-16007



OLO-DHL-16008

1. Die-cast aluminum body
2. Clear glass
3. Lamp: LED45-100W
4. Diameter of spigot: $\varnothing 48\text{mm}$

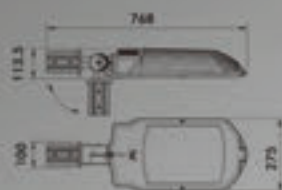



OLO-DHL-16009

PRODUCT DESCRIPTION:

- Body: Made of high quality cast aluminum alloy with treatment of corrosion protection and UV-proof powder coating.
- Diffuser: Clear glass
- Reflector: Made of anodized high pure aluminum.
- Gasketing: Made of thermostable silica gel to improve protection class.
- Fastener: Made of stainless steel with high intensity and corrosion protection.

TECHNICAL DATA:

- Protection Class: IP65
- Application: Urban streets , Parks,Squares,Gardens,Hotels,Villas and so on.
- Lamp: LED 45-100W x 1
- Finish: Matt black as standard.Matt coffee, Dark grey ,Dark bronze,Matt grey any other RAL color is available upon request.

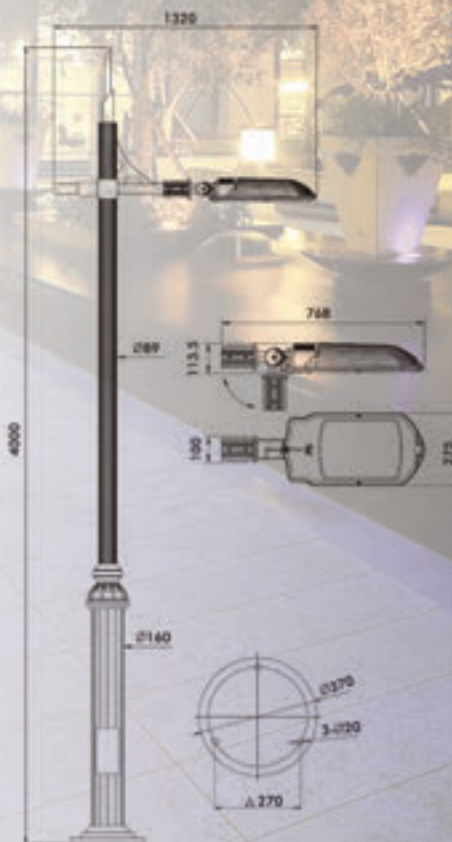

OLO-DHL-16009

OLO-DHL-16010**PRODUCT DESCRIPTION:**

- Body: Made of high quality cast aluminum alloy with treatment of corrosion protection and UV-proof powder coating.
- Diffuser: Clear glass
- Reflector: Made of anodized high pure aluminum.
- Gasketing: Made of thermostable silica gel to improve protection class.
- Fastener: Made of stainless steel with high intensity and corrosion protection.

TECHNICAL DATA:

- Protection Class: IP65
- Application: Urban streets , Parks,Squares,Gardens,Hotels,Villas and so on.
- Lamp: LED 45-100W x 1
- Finish: Matt grey as standard.Matt coffee, Dark grey , Dark bronze, Matt black any other RAL color is available upon request.

**OLO-DHL-16010**

OLO-DHL-16011

PRODUCT DESCRIPTION:

- Body: Made of high quality cast aluminum alloy with treatment of corrosion protection and UV-proof powder coating.
- Diffuser: Clear glass
- Reflector: Made of anodized high pure aluminum.
- Gasketing: Made of thermostable silica gel to improve protection class.
- Fastener: Made of stainless steel with high intensity and corrosion protection.

TECHNICAL DATA:

- Protection Class: IP65
- Application: Urban streets , Parks,Squares,Gardens,Hotels,Villas and so on.
- Lamp: LED 45-100W x 1
- Finish: Matt black as standard.Matt coffee, Dark grey ,Dark bronze,Matt grey any other RAL color is available upon request.

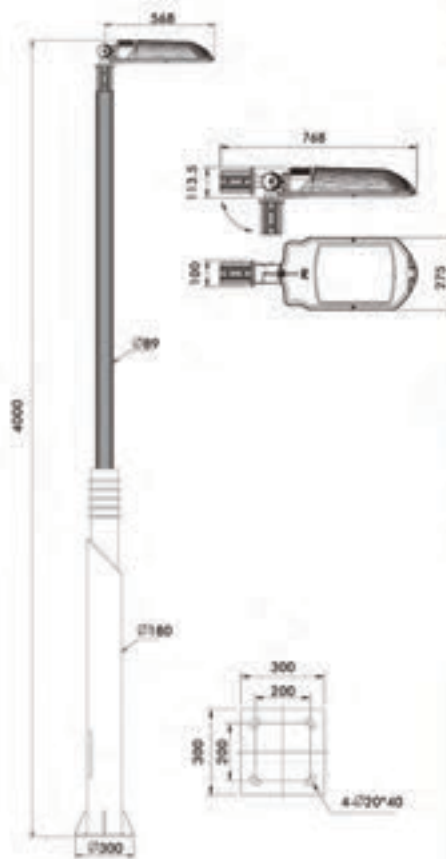

OLO-DHL-16011

OLO-DHL-16012

PRODUCT DESCRIPTION:

- Body: Made of high quality cast aluminum and iron alloy with treatment of corrosion protection and UV-proof powder coating.
- Diffuser: Clear glass
- Reflector: Made of anodized high pure aluminum.
- Gasketing: Made of thermostable silica gel to improve protection class.
- Fastener: Made of stainless steel with high intensity and corrosion protection.

TECHNICAL DATA:

- Protection Class: IP65
- Application: Urban streets , Parks,Squares,Gardens,Hotels,Villas and so on.
- Lamp: LED 45-100W x 1
- Finish: Matt black as standard.Matt coffee, Dark grey ,Dark bronze,Matt grey any other RAL color is available upon request.



OLO-DHL-16012

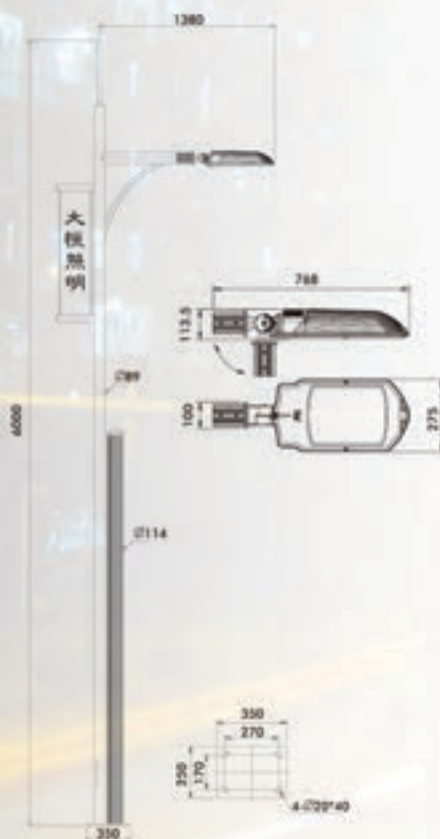



OLO-DHL-16014

1. Die-cast aluminum body
2. Clear glass
3. Lamp: LED45-75W
4. Diameter of spigot: $\varnothing 42\text{mm}$

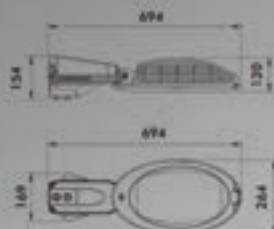

OLO-DHL-16015

PRODUCT DESCRIPTION:

- Body: Made of high quality cast aluminum alloy with treatment of corrosion protection and UV-proof powder coating.
- Diffuser: Clear glass
- Reflector: Made of anodized high pure aluminum.
- Gasketing: Made of thermostable silica gel to improve protection class.
- Fastener: Made of stainless steel with high intensity and corrosion protection.

TECHNICAL DATA:

- Protection Class: IP65
- Application: Urban streets , Parks,Squares,Gardens,Hotels,Villas and so on.
- Lamp: LED 45-75Wx2
- Finish: Matt black as standard.Matt coffee, Dark grey ,Dark bronze,Matt grey any other RAL color is available upon request.

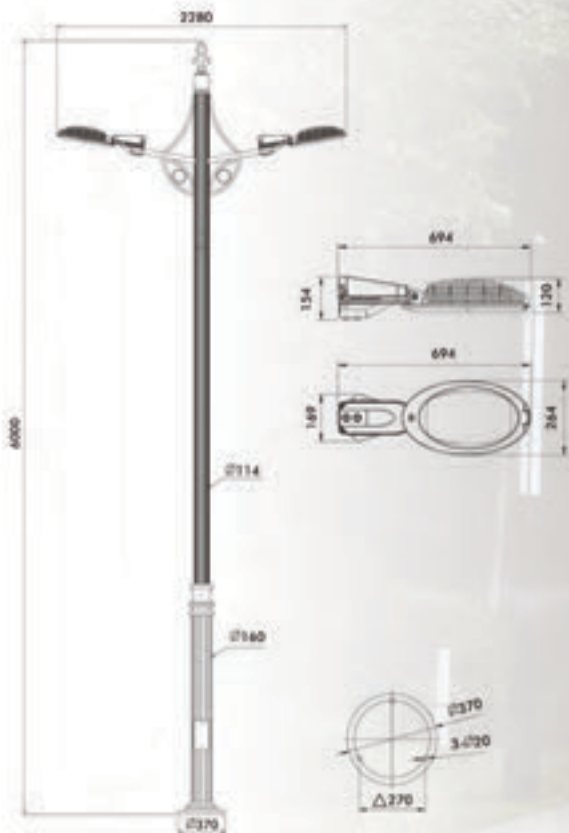

OLO-DHL-16015

OLO-DHL-16016**PRODUCT DESCRIPTION:**

- Body: Made of high quality cast aluminum alloy with treatment of corrosion protection and UV-proof powder coating.
- Diffuser: Clear glass
- Reflector: Made of anodized high pure aluminum.
- Gasketing: Made of thermostable silica gel to improve protection class.
- Fastener: Made of stainless steel with high intensity and corrosion protection.

TECHNICAL DATA:

- Protection Class: IP65
- Application: Urban streets , Parks,Squares,Gardens,Hotels,Villas and so on.
- Lamp: LED 45-75W x 1
- Finish: Matt grey as standard.Matt coffee, Dark grey , Dark bronze, Matt black any other RAL color is available upon request.

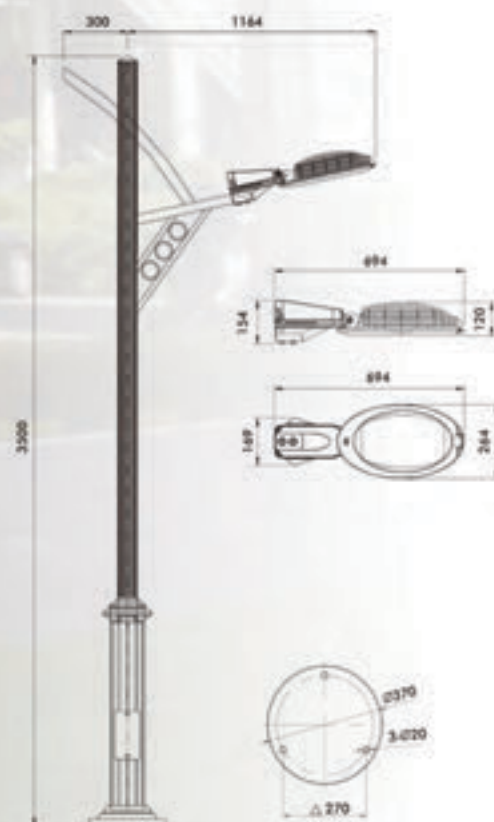
**OLO-DHL-16016**



OLO-DHL-16017

PRODUCT DESCRIPTION:

- Body: Made of high quality cast aluminum alloy with treatment of corrosion protection and UV-proof powder coating.
- Diffuser: Clear glass
- Reflector: Made of anodized high pure aluminum.
- Gasketing: Made of thermostable silica gel to improve protection class.
- Fastener: Made of stainless steel with high intensity and corrosion protection.

TECHNICAL DATA:

- Protection Class: IP65
- Application: Urban streets , Parks,Squares,Gardens,Hotels,Villas and so on.
- Lamp: LED 45-75W x 1
- Finish: Matt grey as standard.Matt coffee, Dark grey , Dark bronze, Matt black any other RAL color is available upon request.

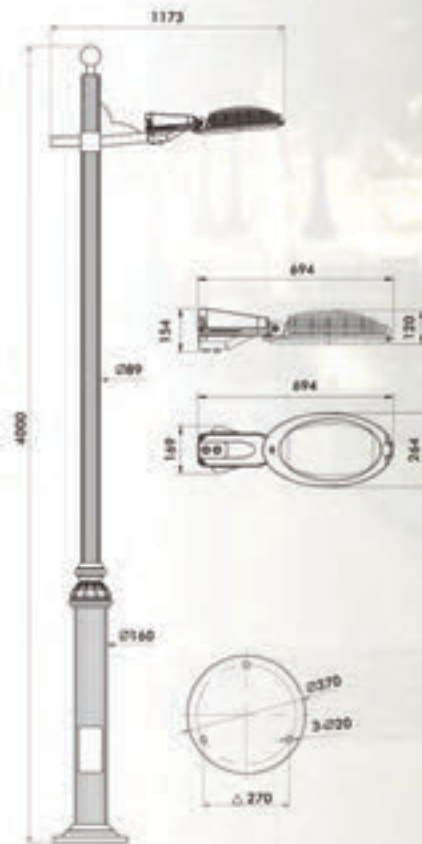

OLO-DHL-16017



OLO-DHL-16018

- 1. Die-cast aluminum body
- 2. Clear glass
- 3. Lamp: LED24-36W



OLO-DHL-16019

PRODUCT DESCRIPTION:

- Body: Made of high quality cast aluminum alloy with treatment of corrosion protection and UV-proof powder coating.
- Diffuser: Clear glass
- Reflector: Made of anodized high pure aluminum.
- Gasketing: Made of thermostable silica gel to improve protection class.
- Fastener: Made of stainless steel with high intensity and corrosion protection.

TECHNICAL DATA:

- Protection Class: IP65
- Application: Urban streets , Parks,Squares,Gardens,Hotels,Villas and so on.
- Lamp: LED 24-36W x 1
- Finish: Dark grey as standard.Matt coffee, Matt black, Dark bronze,Matt grey any other RAL color is available upon request.

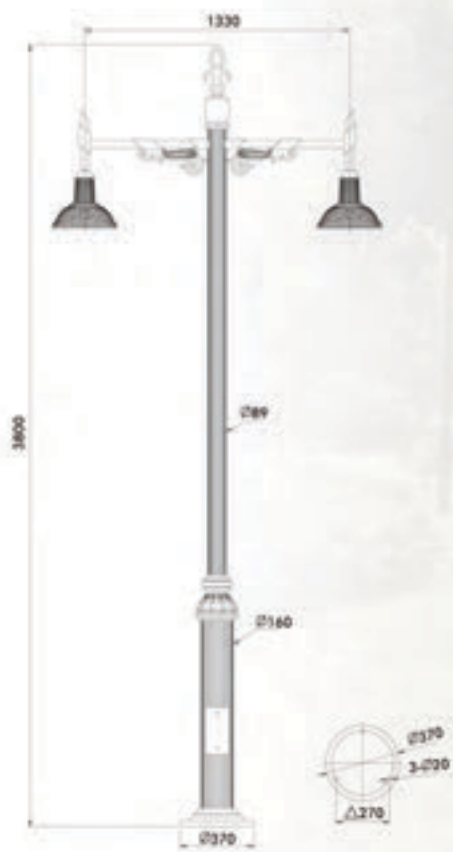

OLO-DHL-16019

OLO-RHT480

PRODUCT DESCRIPTION:

Body: Made of high quality cast aluminum alloy with treatment of corrosion protection and UV-proof powder coating.

Diffuser: Clear glass

Reflector: Made of anodized high pure aluminum.

Gasketing: Made of thermostable silica gel to improve protection class.

Fastener: Made of stainless steel with high intensity and corrosion protection.

TECHNICAL DATA:

Protection Class: IP65

Application: Urban streets , Parks,Squares,Gardens,Hotels,Villas and so on.

Lamp: LED COB 20-40Wx1

Finish: Matt black as standard.Dark grey,Matt grey, Dark bronze,Matt coffee any other RAL color is available upon request.



OLO-RHT480

Product Description:

Material: Extruded aluminum fitting, PC diffuser. With anodized high pure brightened aluminum reflector

Suitable lamp: LED 40W

Finish: Corrosion resistant treatment then with UV-proof powder coating

IP Rate: 65

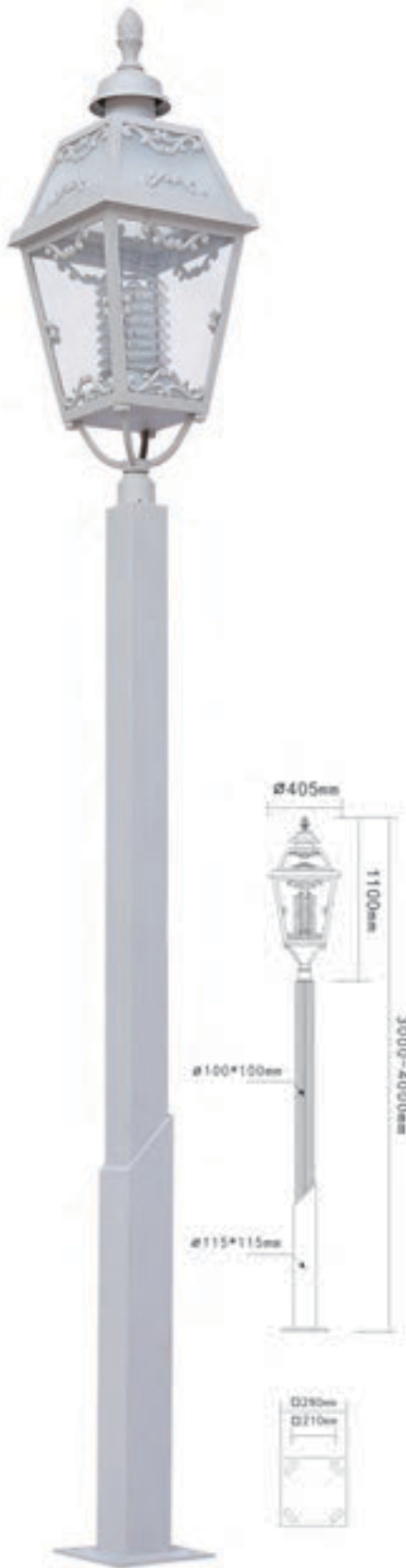

OLO-RHT478

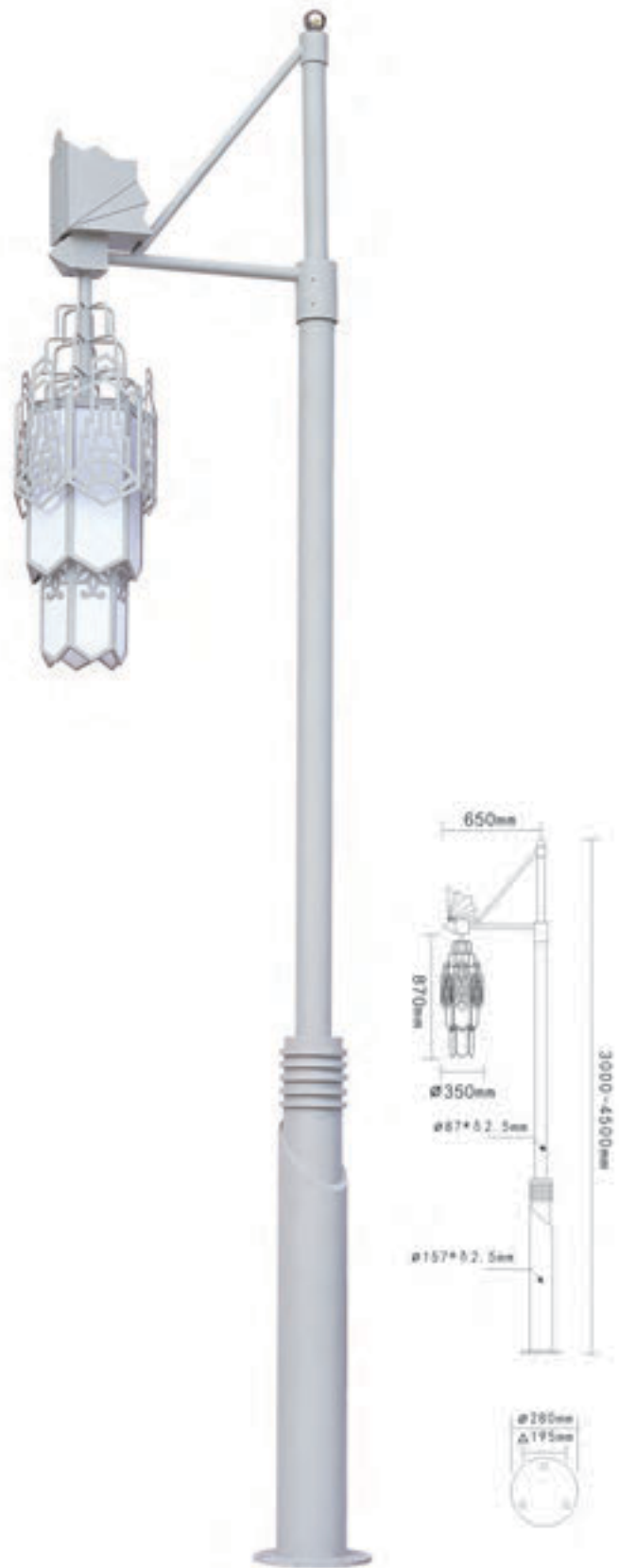

OLO-RHT479

Product Description:

Material: Extruded aluminum fitting, PC diffuser, With anodized high pure brightened aluminum reflector

Suitable lamp: LED 40W

Finish: Corrosion resistant treatment then with UV-proof powder coating

IP Rate: 65



OLO-RHT309

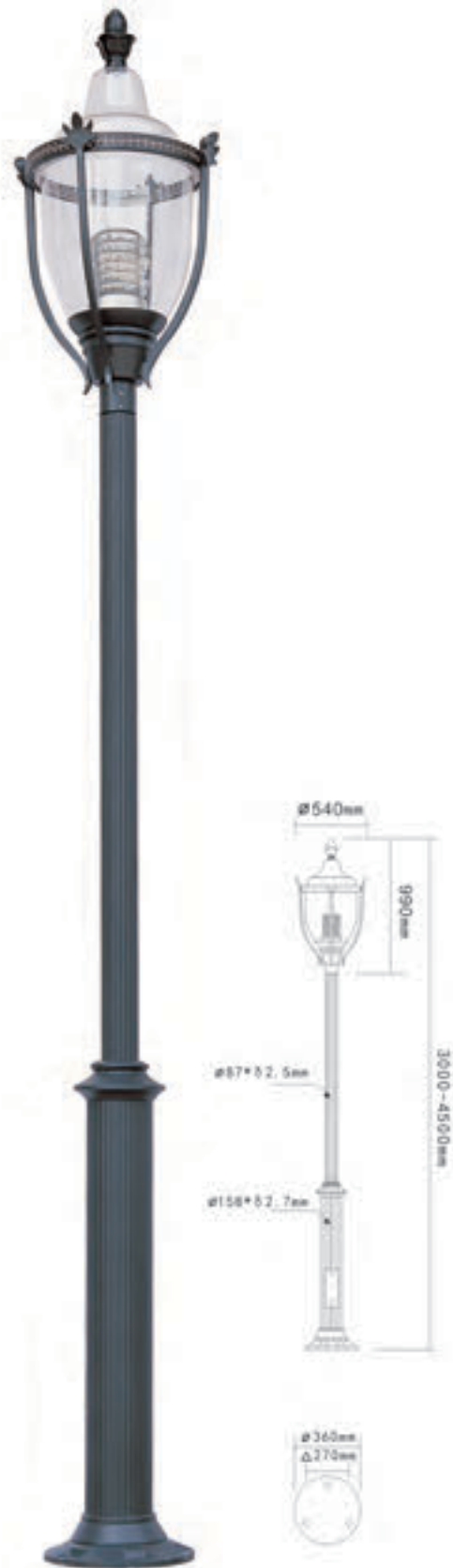

OLO-RHT310

Product Description:

Material: Extruded aluminum fitting, PC diffuser. With anodized high pure brightened aluminum reflector

Suitable lamp: LED 40W

Finish: Corrosion resistant treatment then with UV-proof powder coating

IP Rate: 65



OLO-RHT315

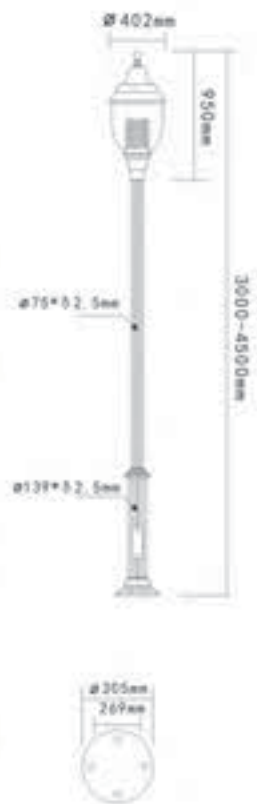
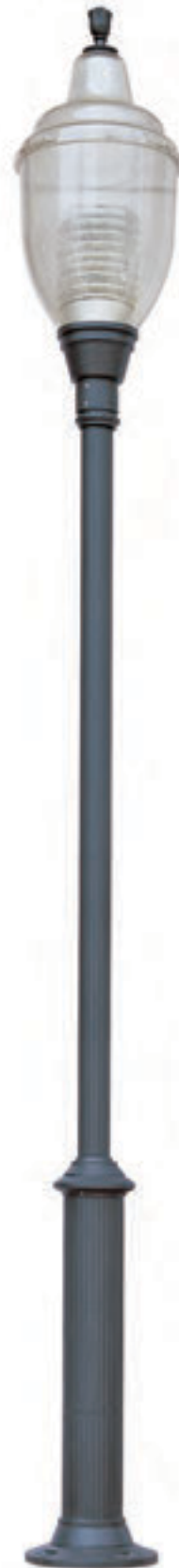

OLO-RHT316

Product Description:

Material: Extruded aluminum fitting, PC diffuser, With anodized high pure brightened aluminum reflector

Suitable lamp: LED 40W

Finish: Corrosion resistant treatment then with UV-proof powder coating

IP Rate: 65



OLO-RHT318

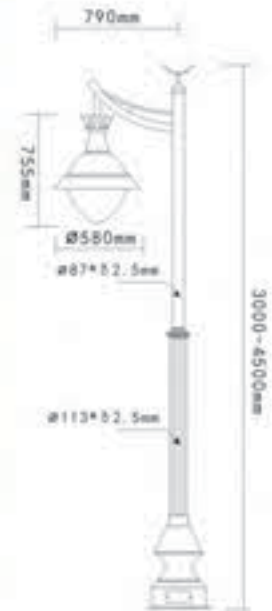

OLO-RHT319

Product Description:

Material: Extruded aluminum fitting, PC diffuser, With anodized high pure brightened aluminum reflector

Suitable lamp: LED 40W

Finish: Corrosion resistant treatment then with UV-proof powder coating

IP Rate: 65



OLO-RHT322

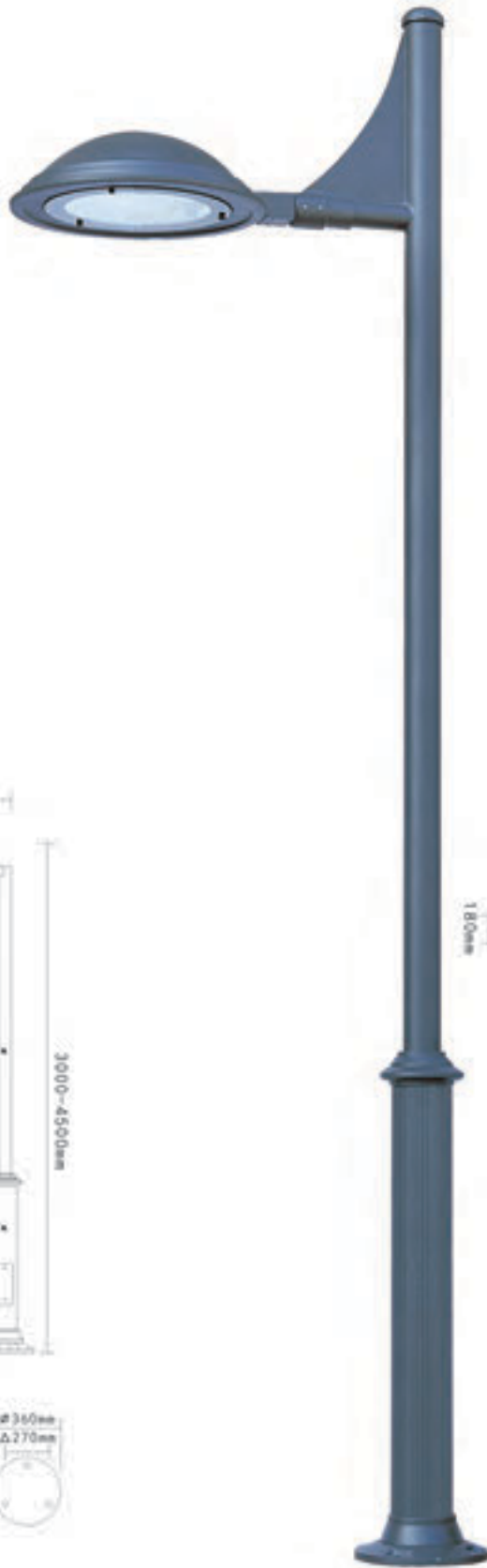

OLO-RHT323

Product Description:

Material: Extruded aluminum fitting, PC diffuser, With anodized high pure brightened aluminum reflector

Suitable lamp: LED 40W

Finish: Corrosion resistant treatment then with UV-proof powder coating

IP Rate: 65

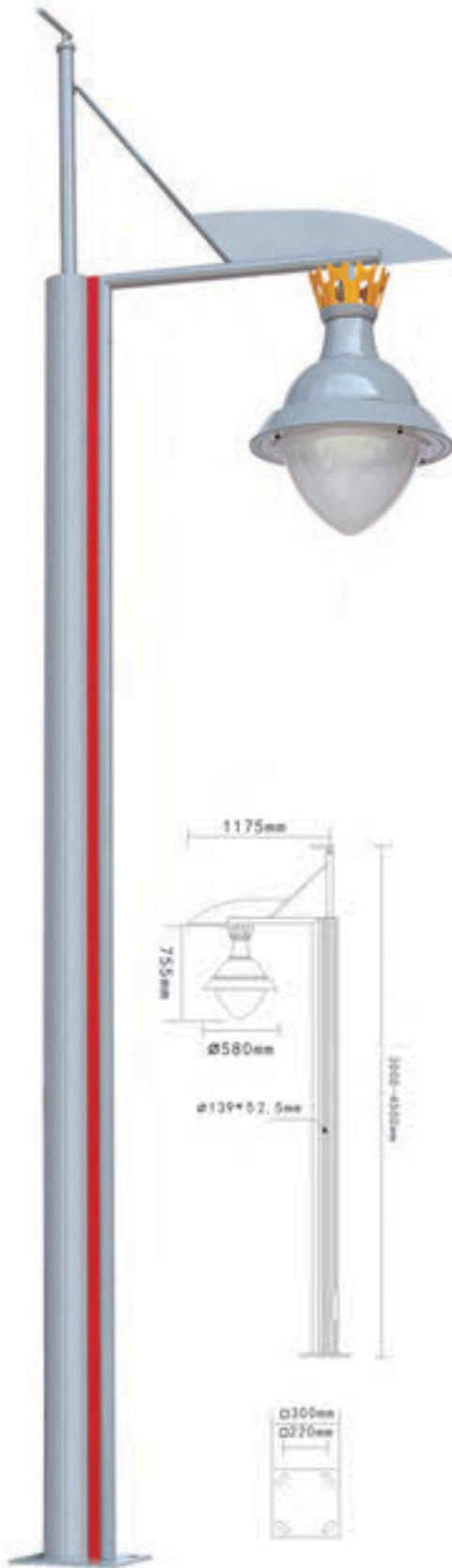

OLO-RHT324

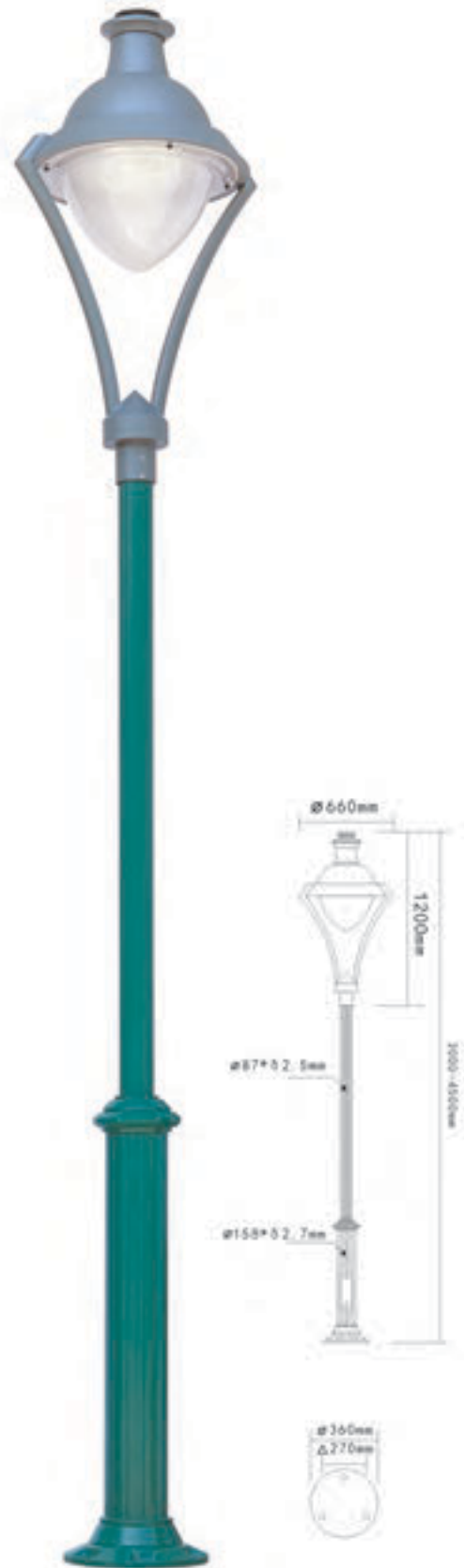

OLO-RHT325

Product Description:

Material: Extruded aluminum fitting, PC diffuser, With anodized high pure brightened aluminum reflector

Suitable lamp: LED 40W

Finish: Corrosion resistant treatment then with UV-proof powder coating

IP Rate: 65



OLO-RHT307



OLO-RHT308



Product Description:

Material: Extruded aluminum fitting, PC diffuser. With anodized high pure brightened aluminum reflector

Suitable lamp: LED 40W

Finish: Corrosion resistant treatment then with UV-proof powder coating

IP Rate: 65

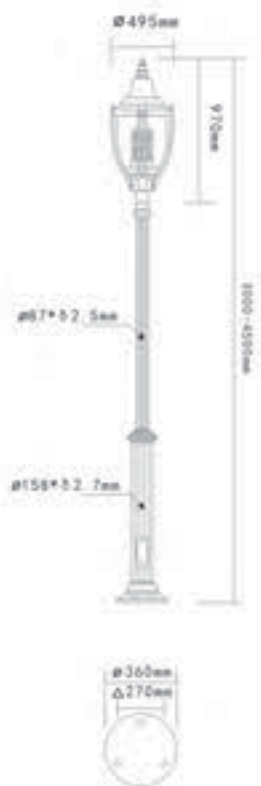
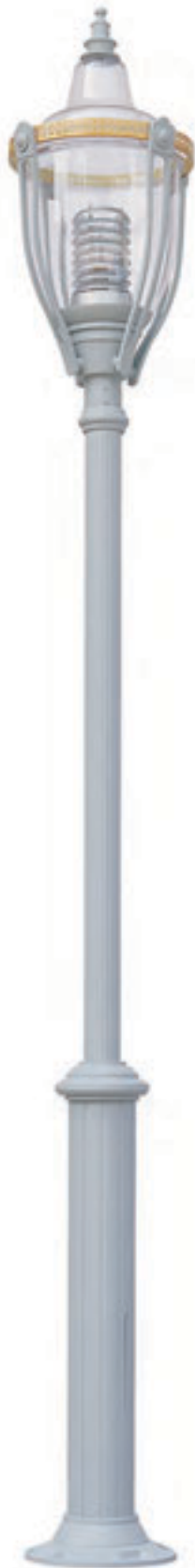

OLO-RHT328

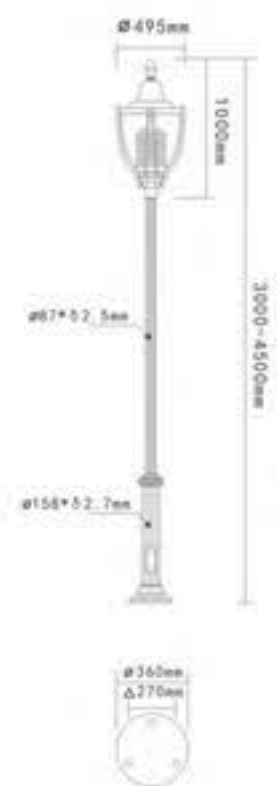

OLO-RHT329

Product Description:

Material: Extruded aluminum fitting, PC diffuser, With anodized high pure brightened aluminum reflector

Suitable lamp: LED 40W

Finish: Corrosion resistant treatment then with UV-proof powder coating

IP Rate: 65

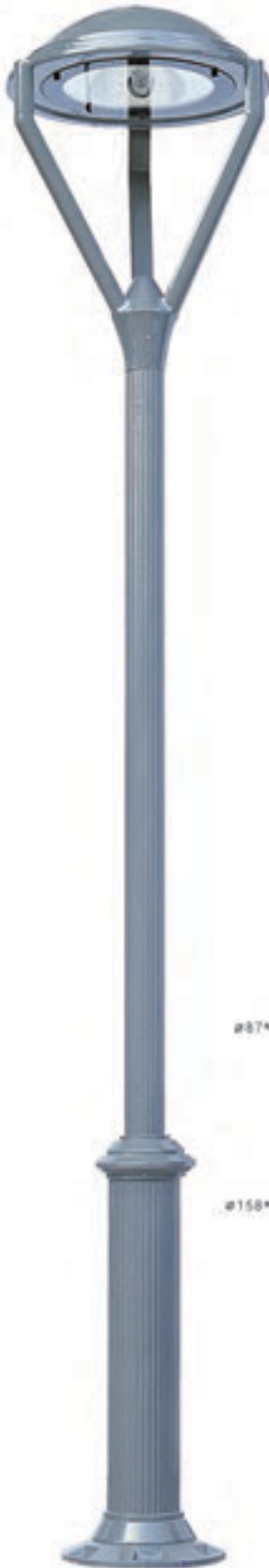

OLO-RHT332

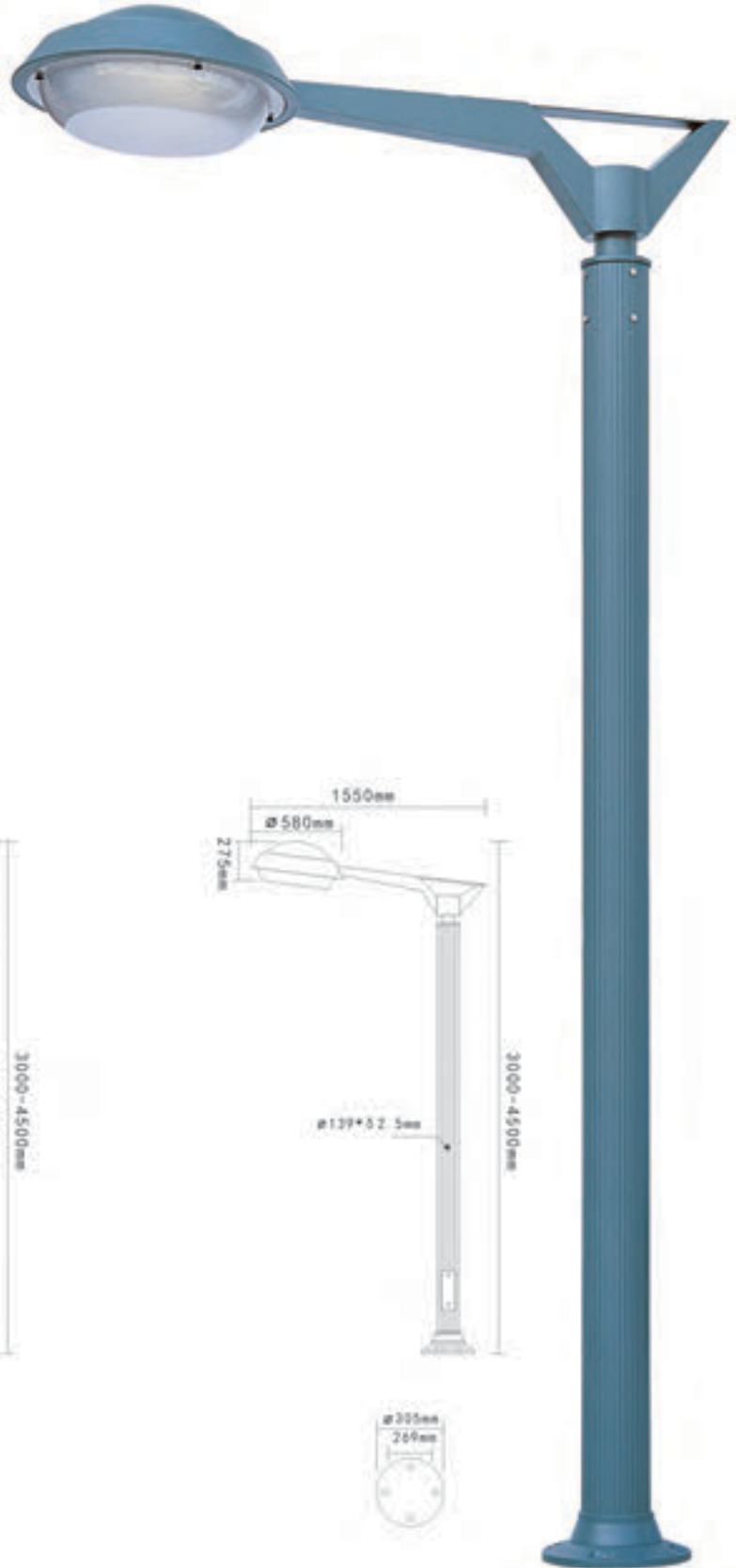

OLO-RHT333

Product Description:

Material: Extruded aluminum fitting, PC diffuser, With anodized high pure brightened aluminum reflector

Suitable lamp: LED 40W

Finish: Corrosion resistant treatment then with UV-proof powder coating

IP Rate: 65



OLO-RHT369

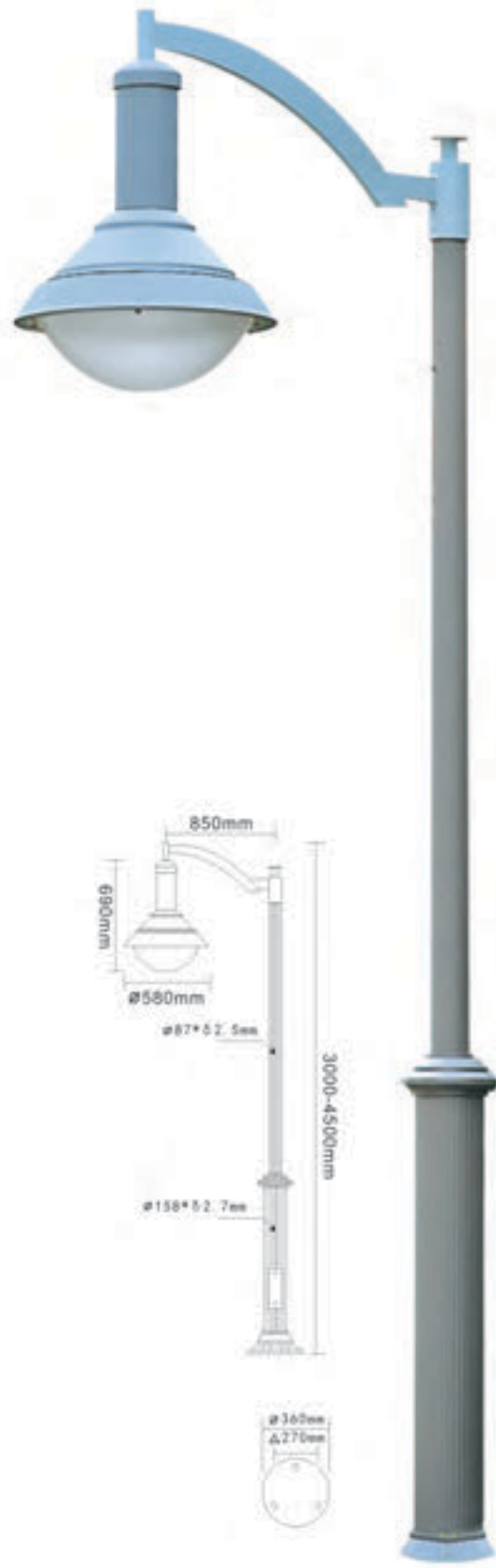

OLO-RHT368



Product Description:

Material: Extruded aluminum fitting, PC diffuser, With anodized high pure brightened aluminum reflector

Suitable lamp: LED 40W

Finish: Corrosion resistant treatment then with UV-proof powder coating

IP Rate: 65

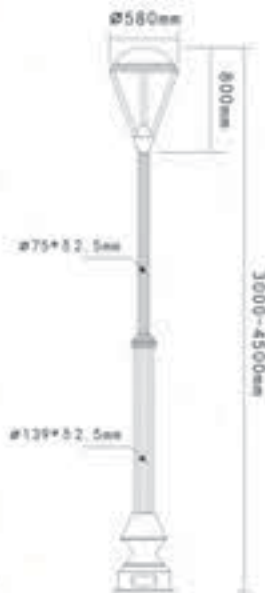

OLO-RHT339

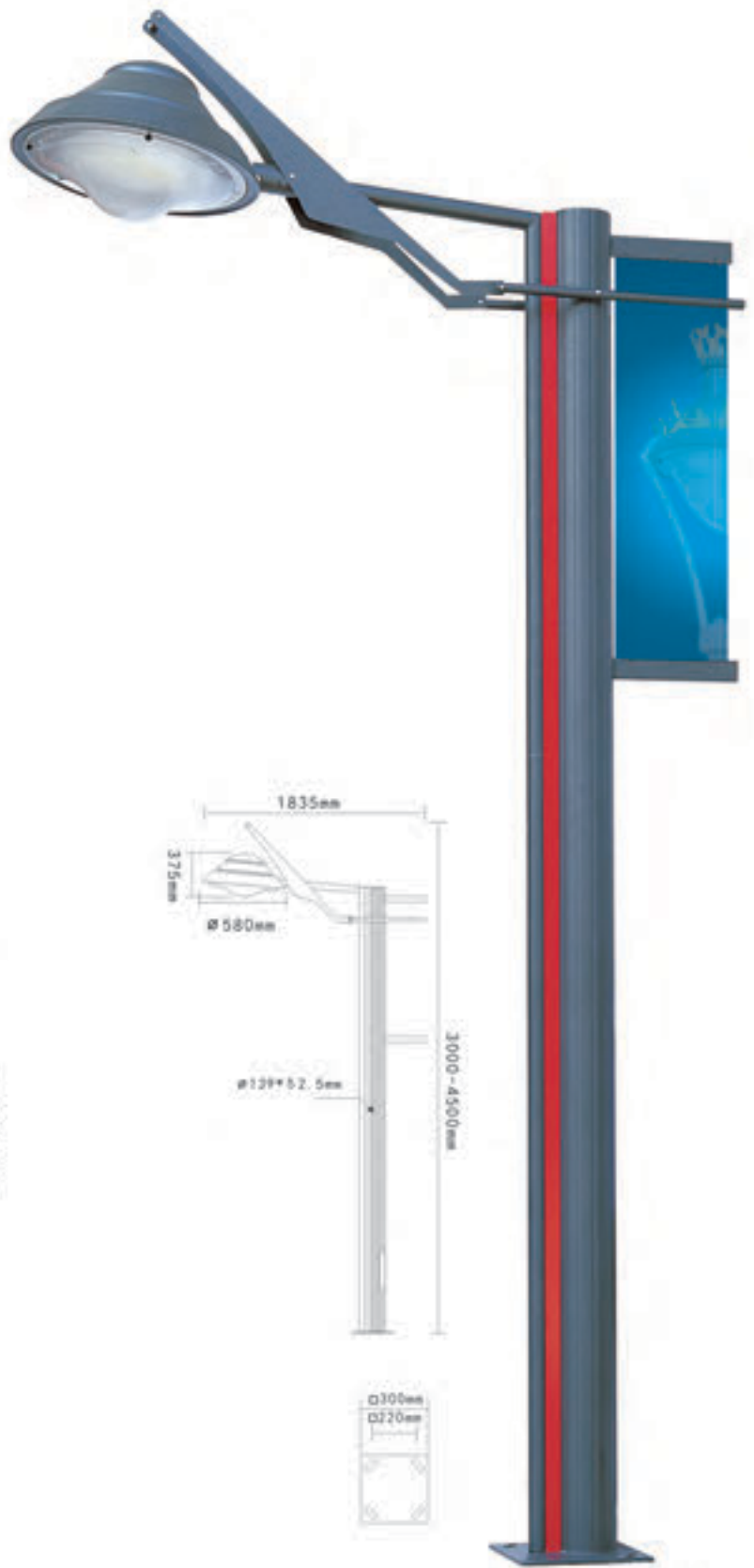

OLO-RHT338

Product Description:

Material: Extruded aluminum fitting, PC diffuser, With anodized high pure brightened aluminum reflector

Suitable lamp: LED 40W

Finish: Corrosion resistant treatment then with UV-proof powder coating

IP Rate: 65

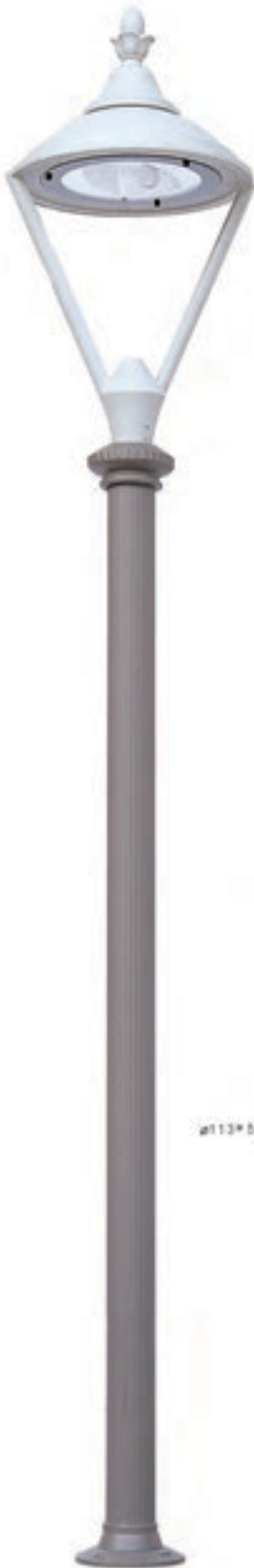

OLO-RHT340

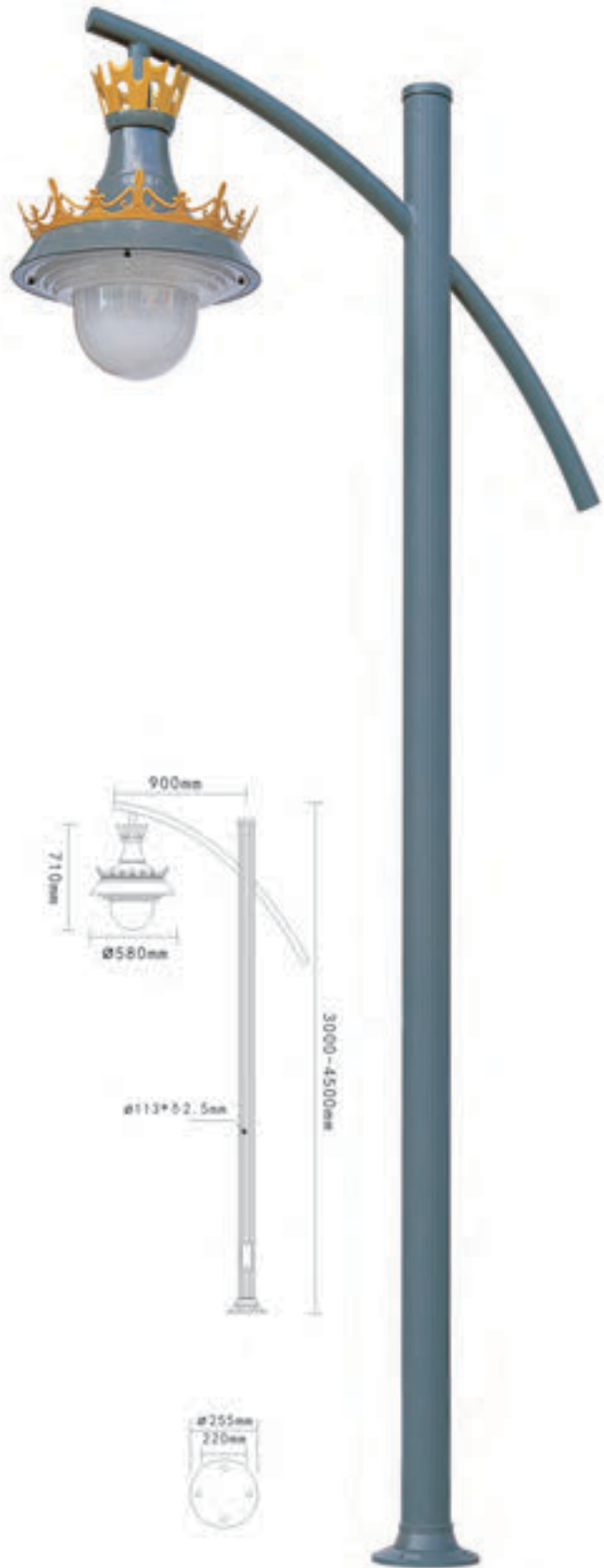

OLO-RHT341

Product Description:

Material: Extruded aluminum fitting, PC diffuser. With anodized high pure brightened aluminum reflector

Suitable lamp: LED 40W

Finish: Corrosion resistant treatment then with UV-proof powder coating

IP Rate: 65

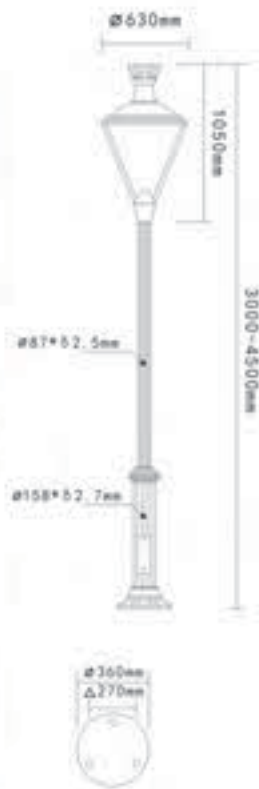

OLO-RHT347

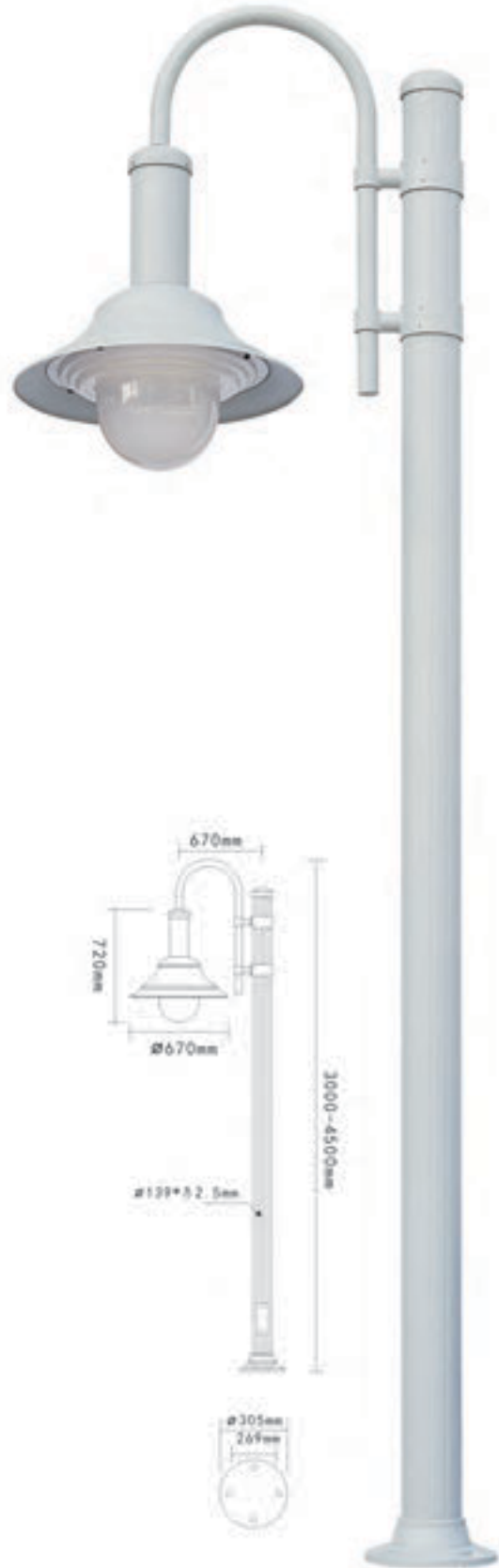

OLO-RHT346

Product Description:

Material: Extruded aluminum fitting, PC diffuser, With anodized high pure brightened aluminum reflector

Suitable lamp: LED 40W

Finish: Corrosion resistant treatment then with UV-proof powder coating

IP Rate: 65

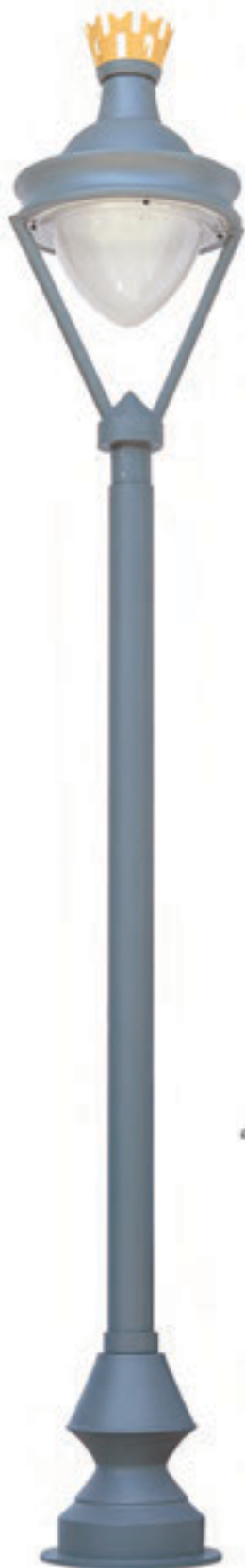

OLO-RHT349

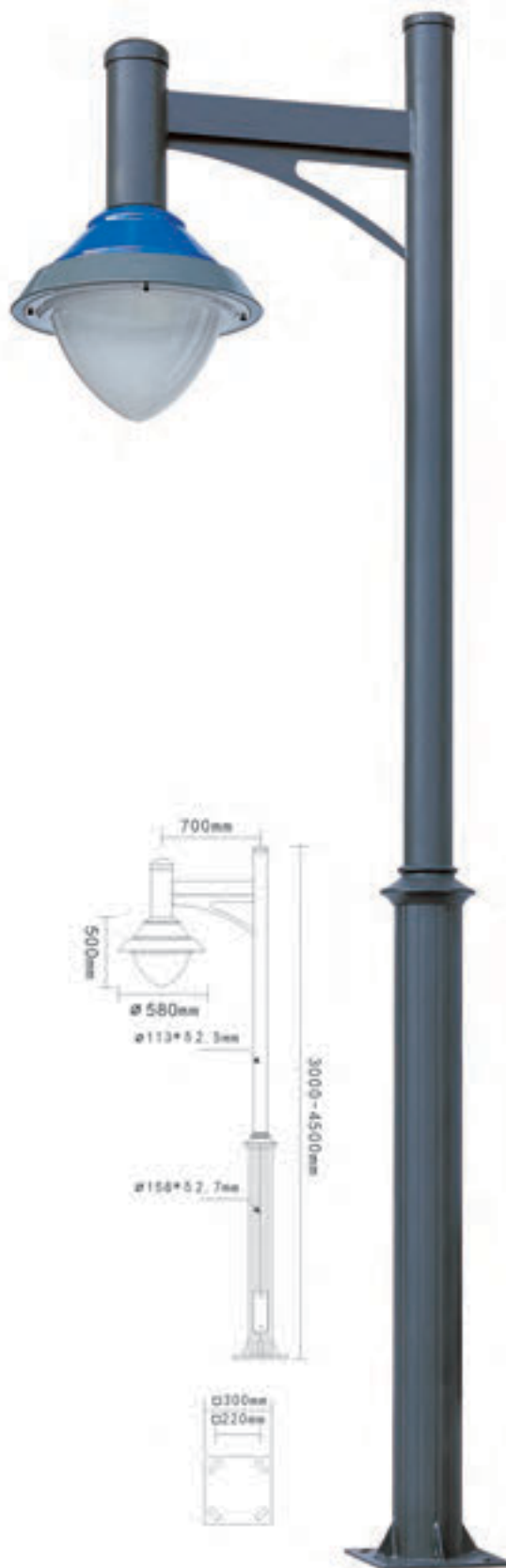

OLO-RHT348



Product Description:

Material: Extruded aluminum fitting, PC diffuser, With anodized high pure brightened aluminum reflector

Suitable lamp: LED 40W

Finish: Corrosion resistant treatment then with UV-proof powder coating

IP Rate: 65

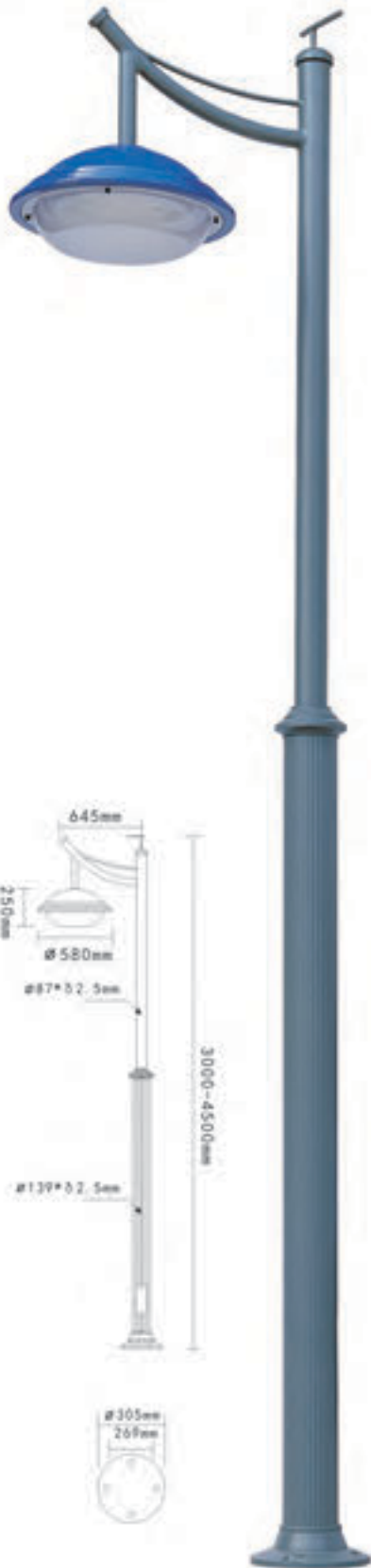

OLO-RHT354

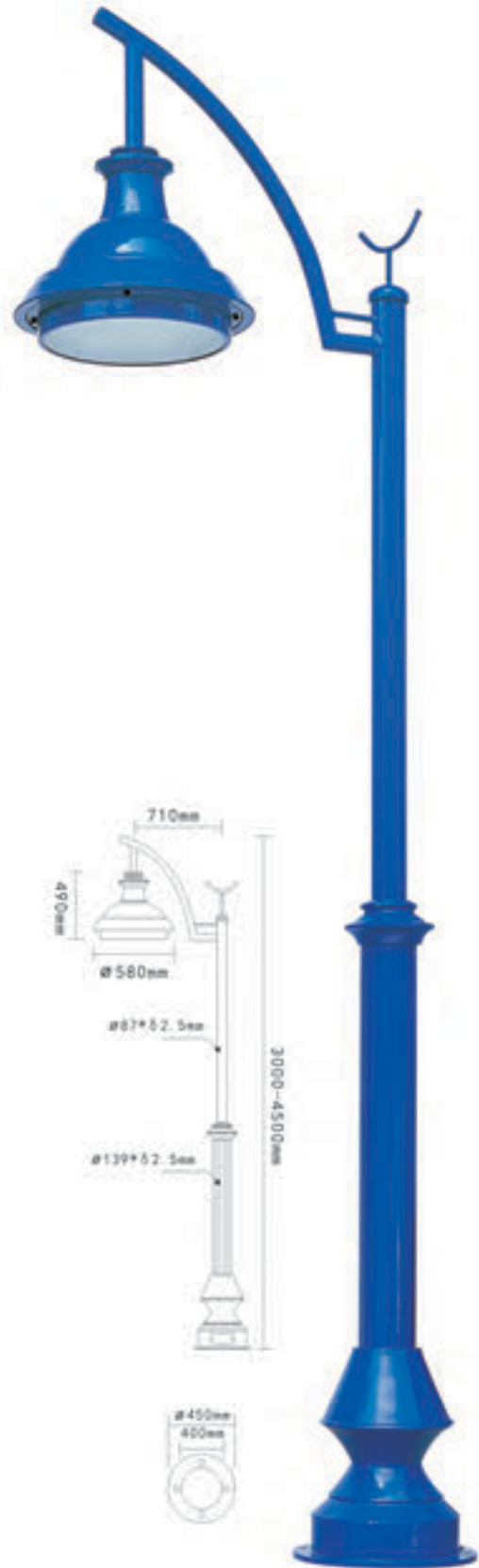

OLO-RHT355

Product Description:

Material: Extruded aluminum fitting, PC diffuser. With anodized high pure brightened aluminum reflector

Suitable lamp: LED 40W

Finish: Corrosion resistant treatment then with UV-proof powder coating

IP Rate: 65

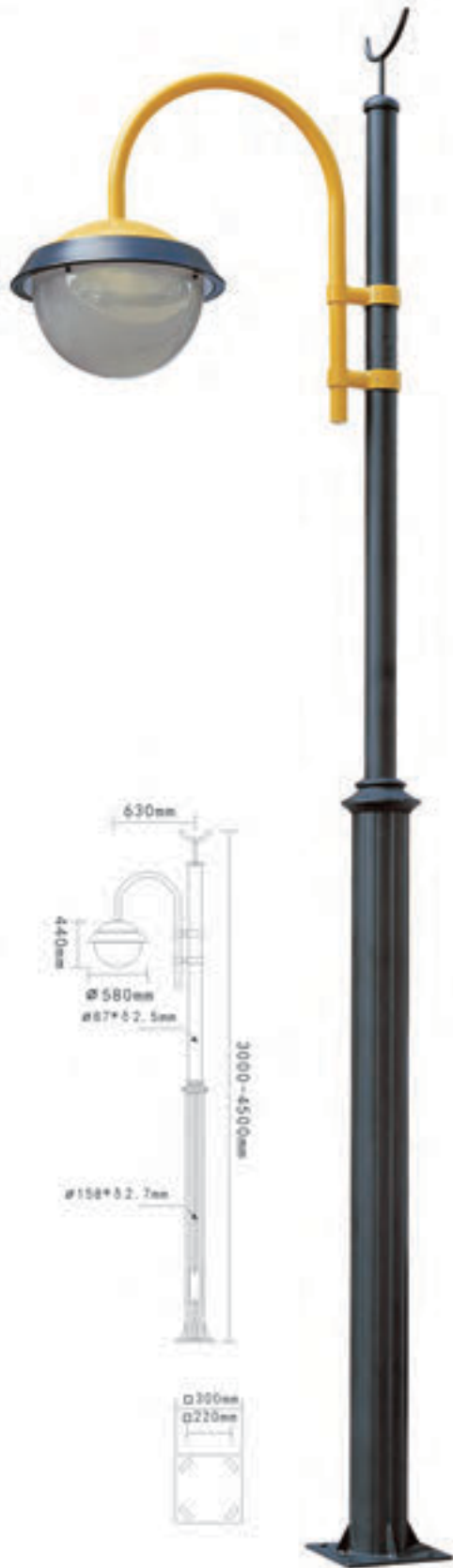

OLO-RHT356

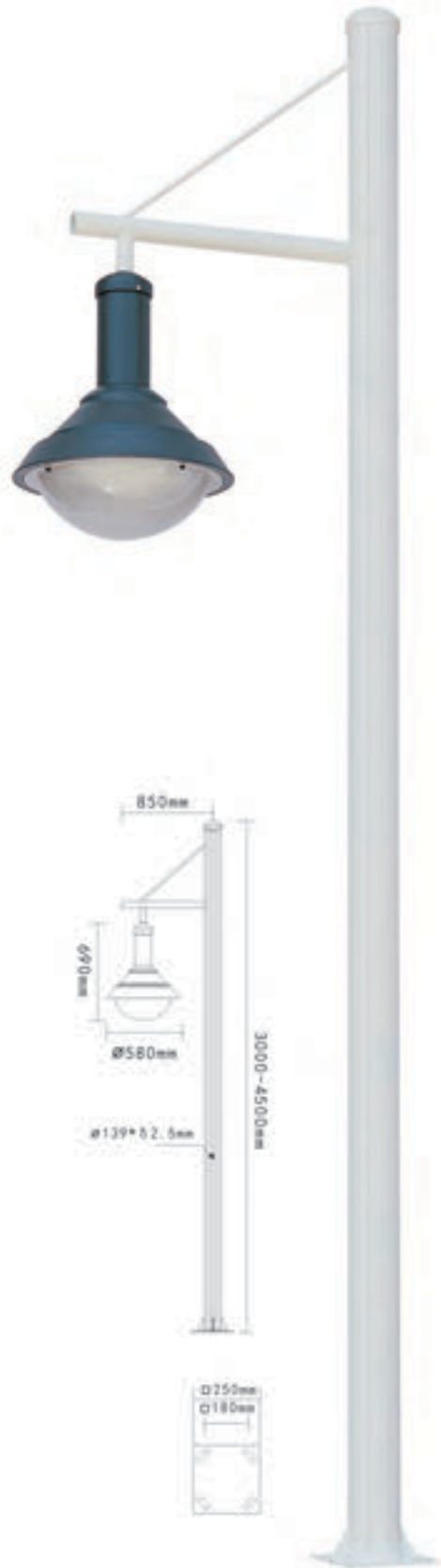

OLO-RHT357

Product Description:

Material: Extruded aluminum fitting, PC diffuser, With anodized high pure brightened aluminum reflector

Suitable lamp: LED 40W

Finish: Corrosion resistant treatment then with UV-proof powder coating

IP Rate: 65

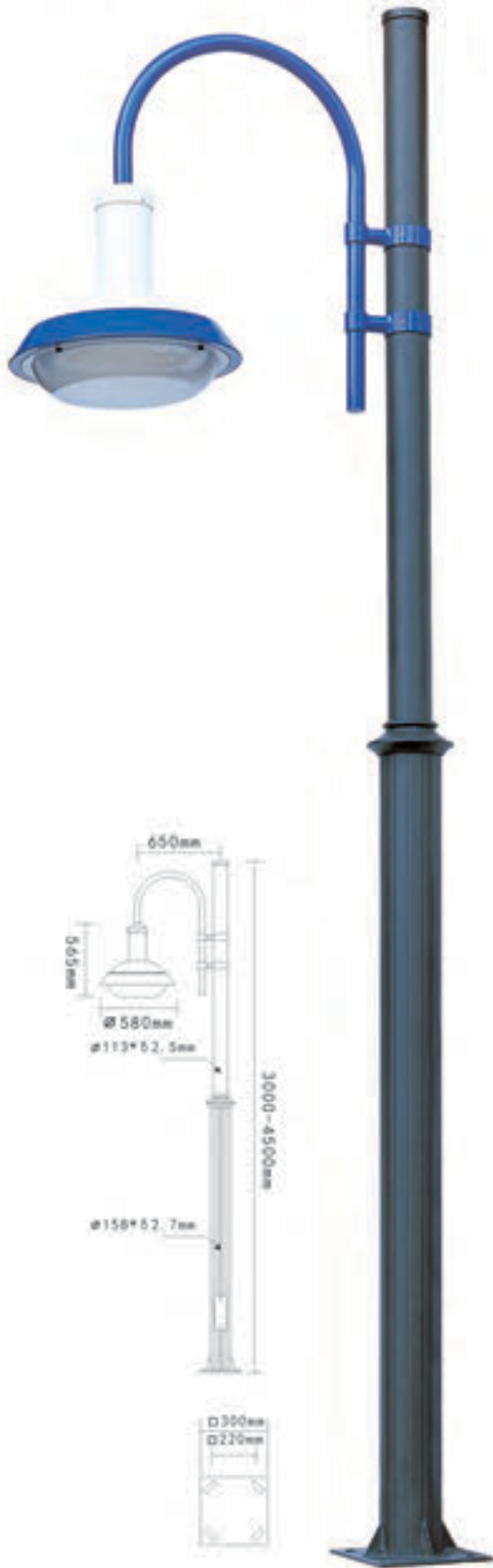

OLO-RHT363

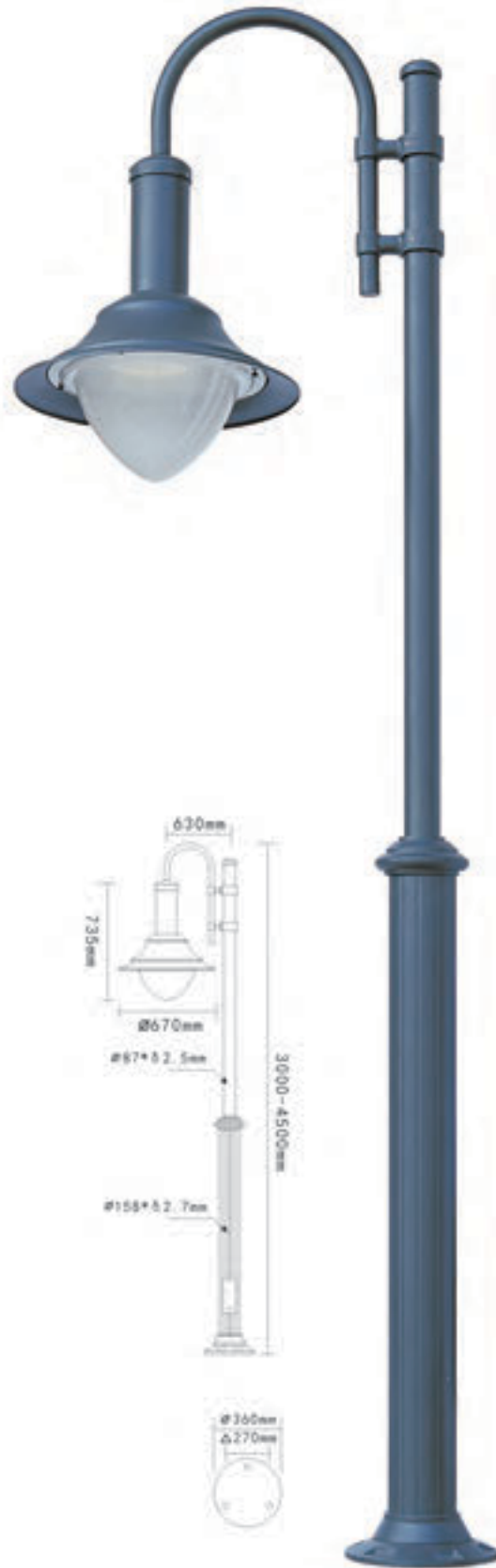

OLO-RHT362

Product Description:

Material: Extruded aluminum fitting, PC diffuser. With anodized high pure brightened aluminum reflector

Suitable lamp: LED 40W

Finish: Corrosion resistant treatment then with UV-proof powder coating

IP Rate: 65

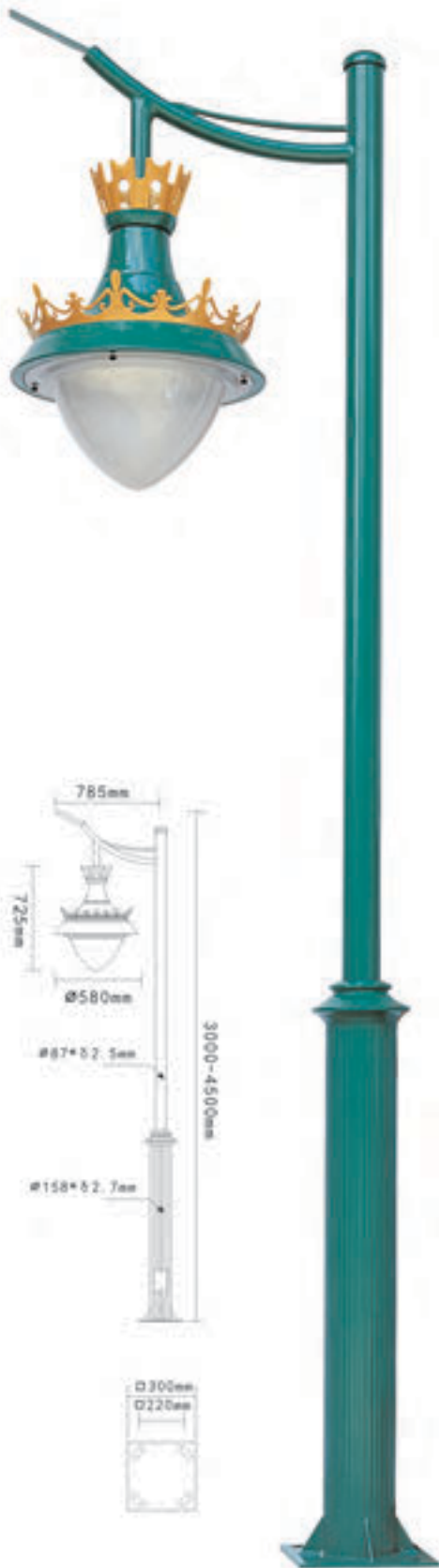

OLO-RHT366

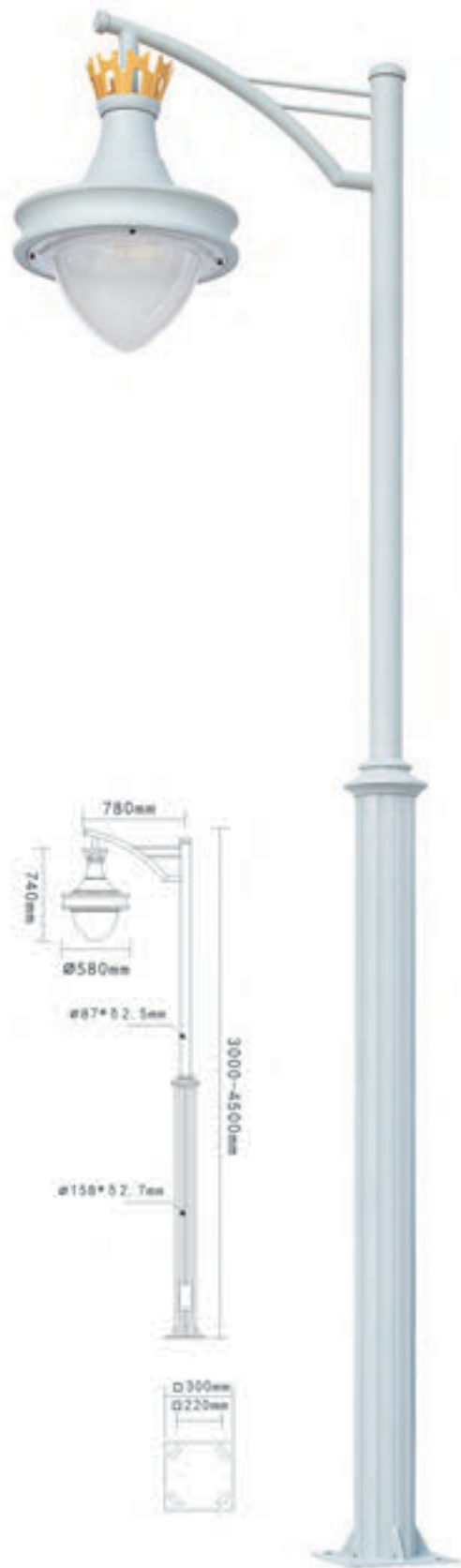

OLO-RHT367



OLO-RHT367-B

Product Description:

Material: Extruded aluminum fitting, PC diffuser, With anodized high pure brightened aluminum reflector

Suitable lamp: LED 40W

Finish: Corrosion resistant treatment then with UV-proof powder coating

IP Rate: 65



OLO-RHT372

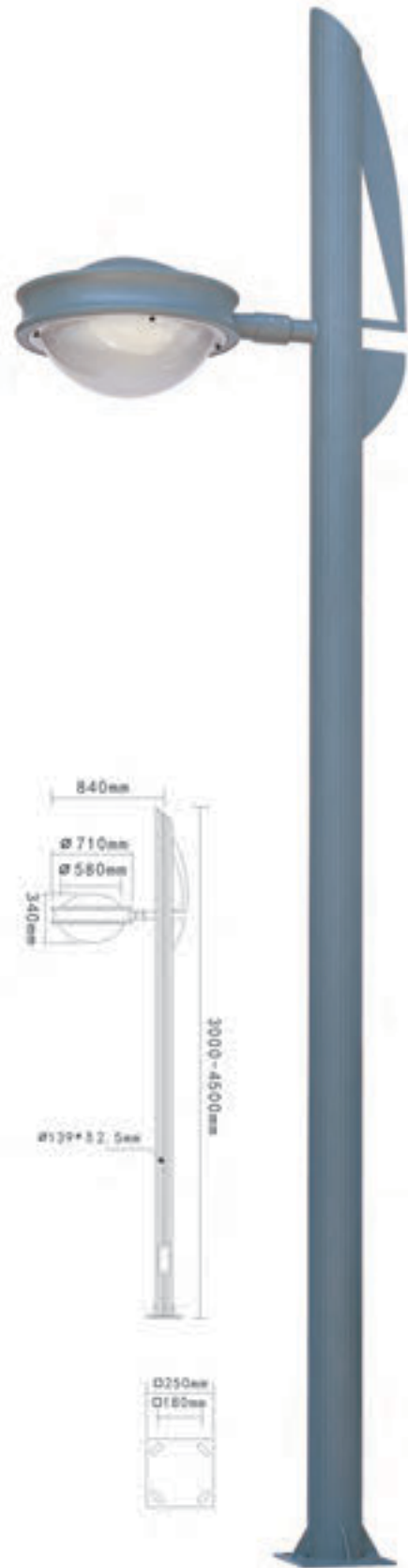

OLO-RHT373

Product Description:

Material: Extruded aluminum fitting, PC diffuser. With anodized high pure brightened aluminum reflector

Suitable lamp: LED 40W

Finish: Corrosion resistant treatment then with UV-proof powder coating

IP Rate: 65



OLO-RHT379

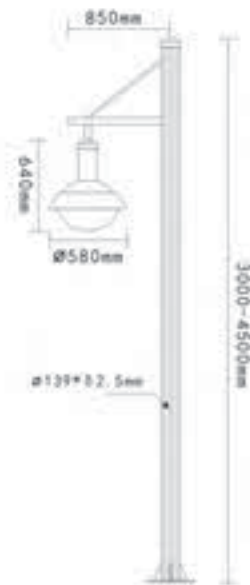
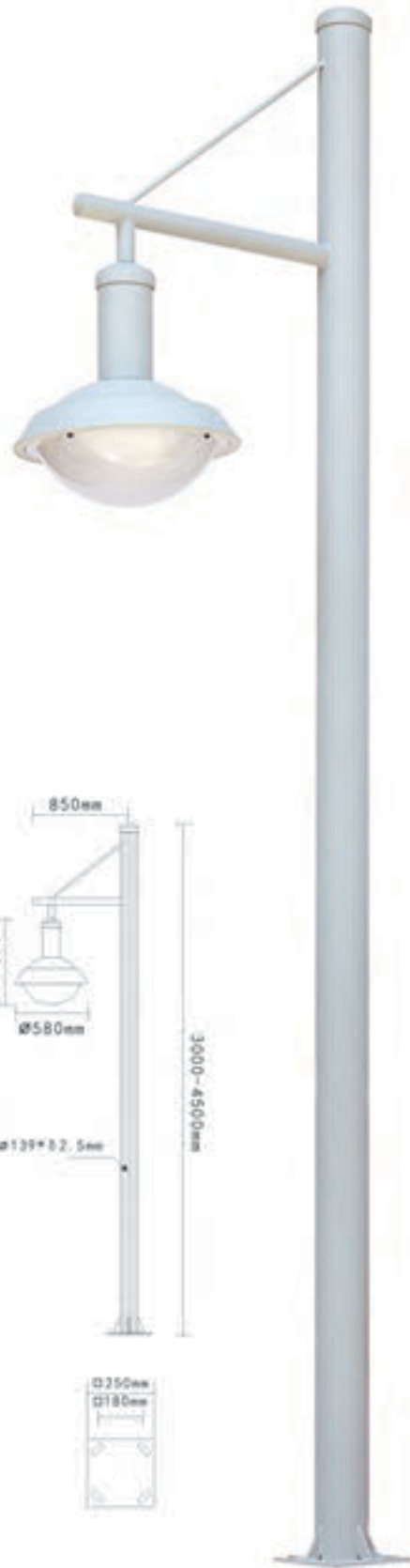

OLO-RHT378

Product Description:

Material: Extruded aluminum fitting, PC diffuser, With anodized high pure brightened aluminum reflector

Suitable lamp: LED 40W

Finish: Corrosion resistant treatment then with UV-proof powder coating

IP Rate: 65

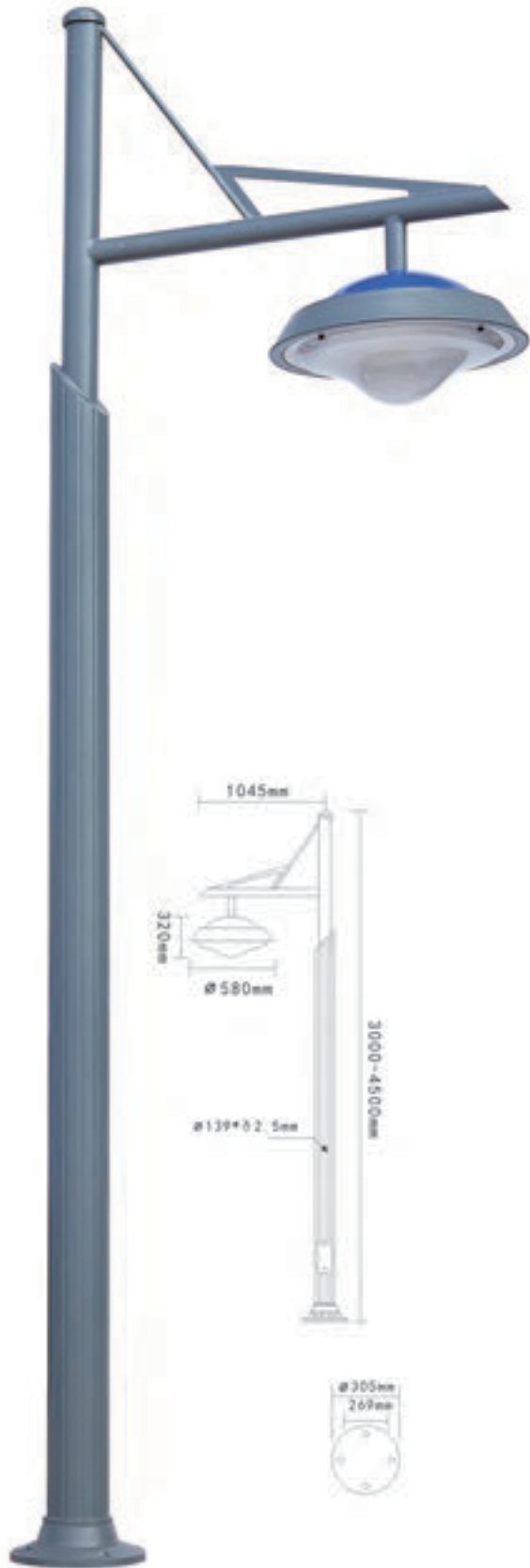

OLO-RHT382

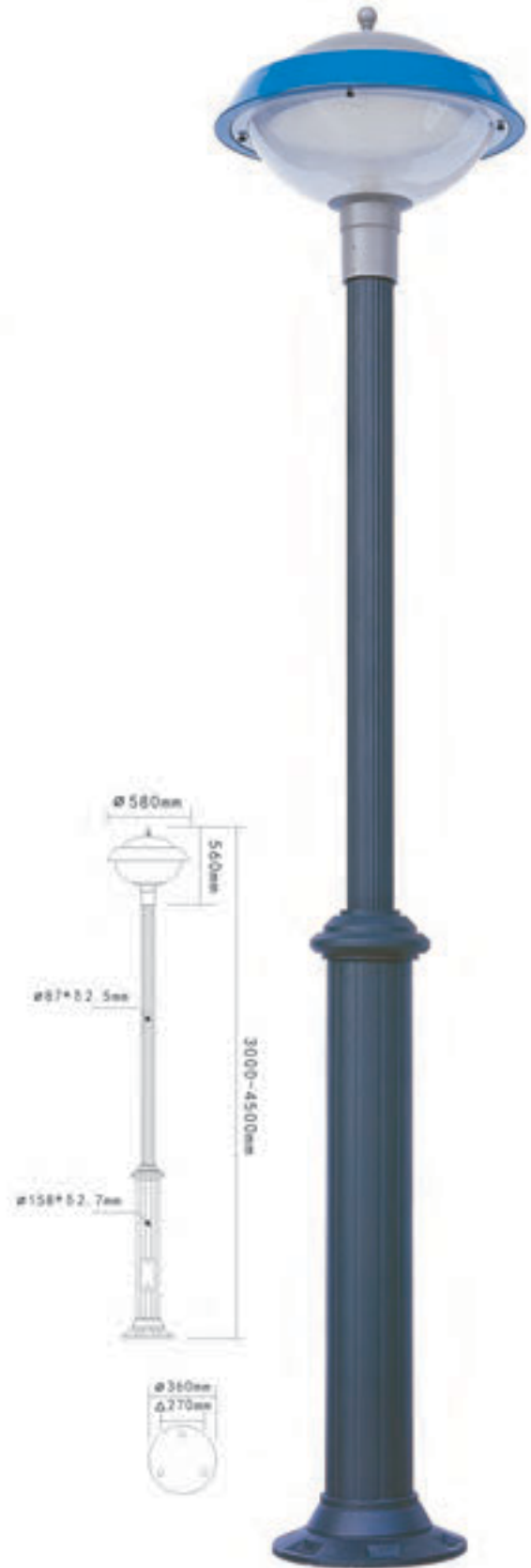

OLO-RHT383

Product Description:

Material: Extruded aluminum fitting, PC diffuser, With anodized high pure brightened aluminum reflector

Suitable lamp: LED 40W

Finish: Corrosion resistant treatment then with UV-proof powder coating

IP Rate: 65

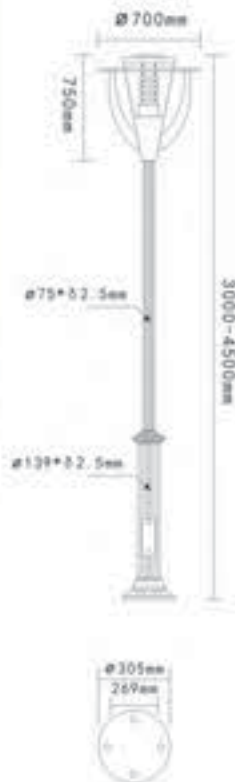

OLO-RHT384

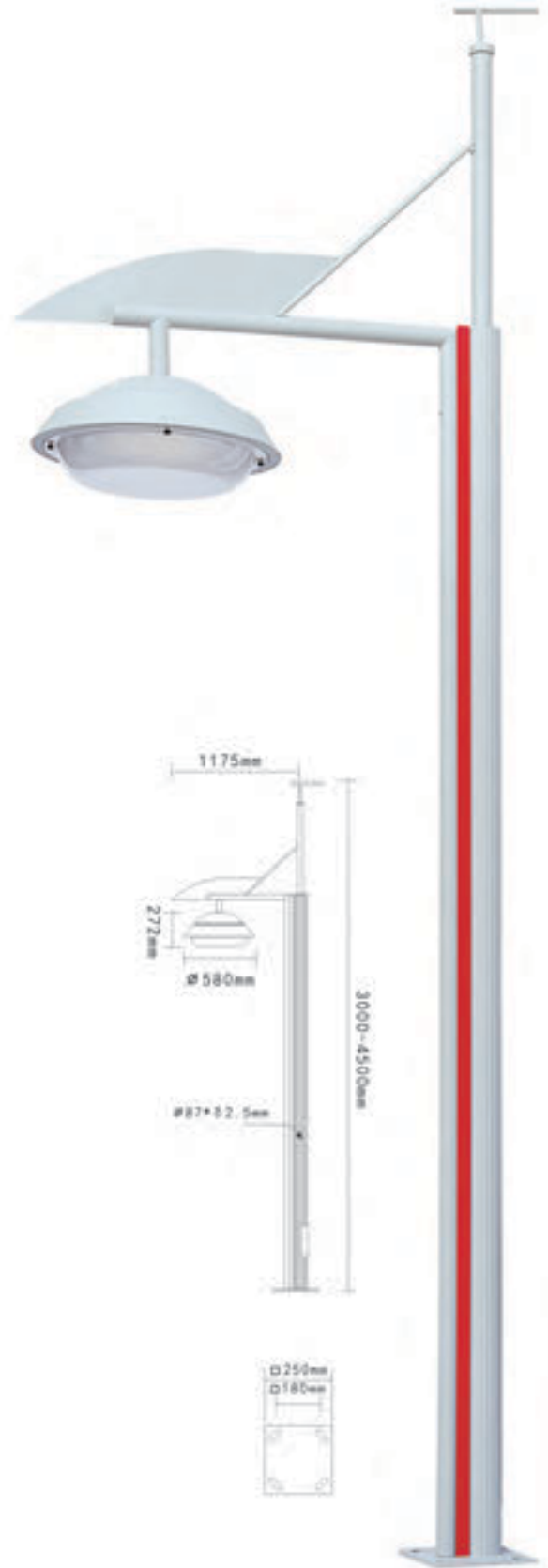

OLO-RHT385

Product Description:

Material: Extruded aluminum fitting, PC diffuser, With anodized high pure brightened aluminum reflector

Suitable lamp: LED 40W

Finish: Corrosion resistant treatment then with UV-proof powder coating

IP Rate: 65



OLO-RHT390

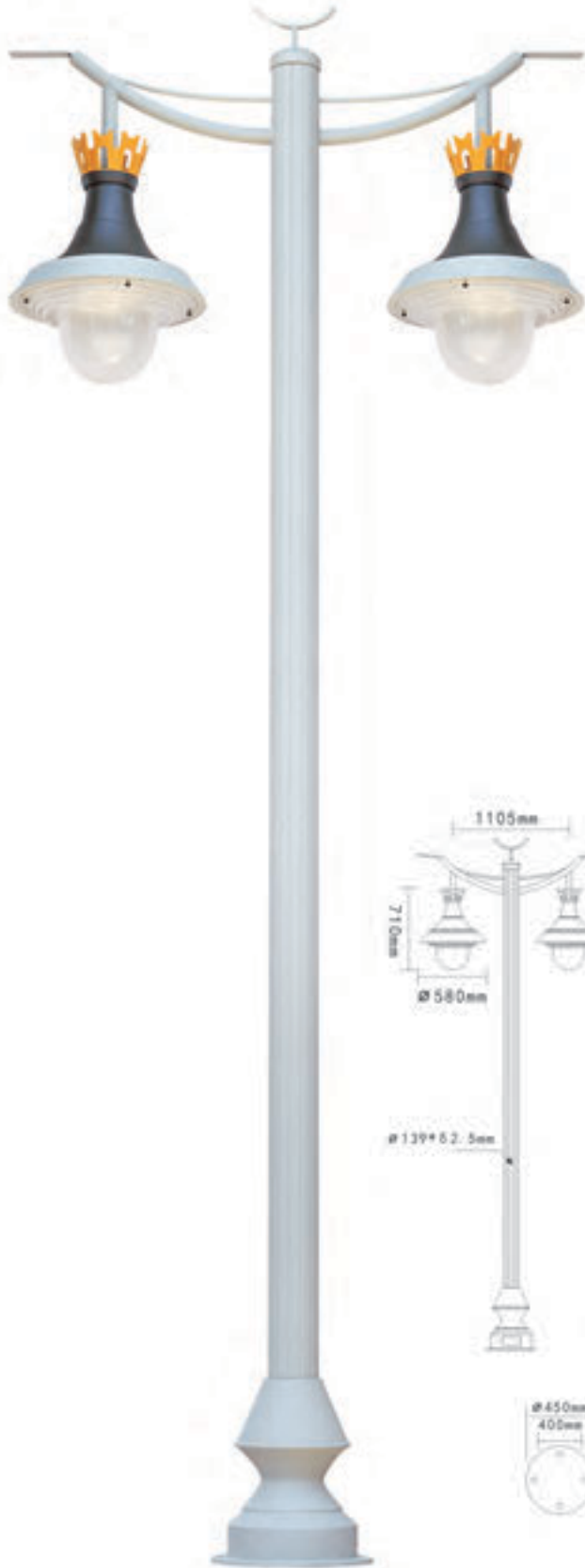

OLO-RHT391

Product Description:

Material: Extruded aluminum fitting, PC diffuser, With anodized high pure brightened aluminum reflector

Suitable lamp: LED 40W

Finish: Corrosion resistant treatment then with UV-proof powder coating

IP Rate: 65



OLO-RHT392

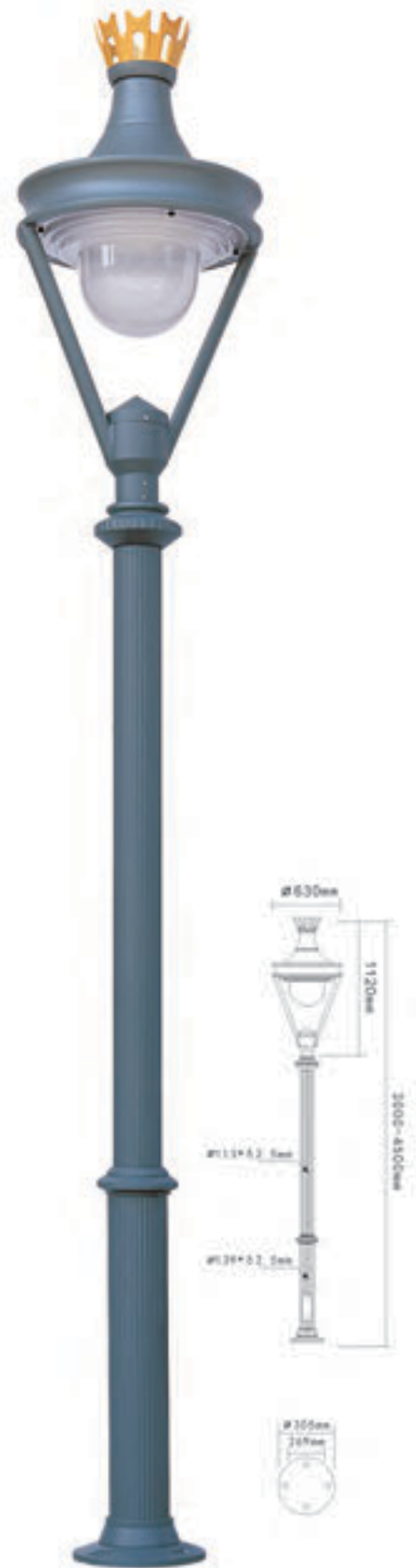

OLO-RHT393

Product Description:

Material: Extruded aluminum fitting, PC diffuser, With anodized high pure brightened aluminum reflector

Suitable lamp: LED 40W

Finish: Corrosion resistant treatment then with UV-proof powder coating

IP Rate: 65



OLO-RHT396

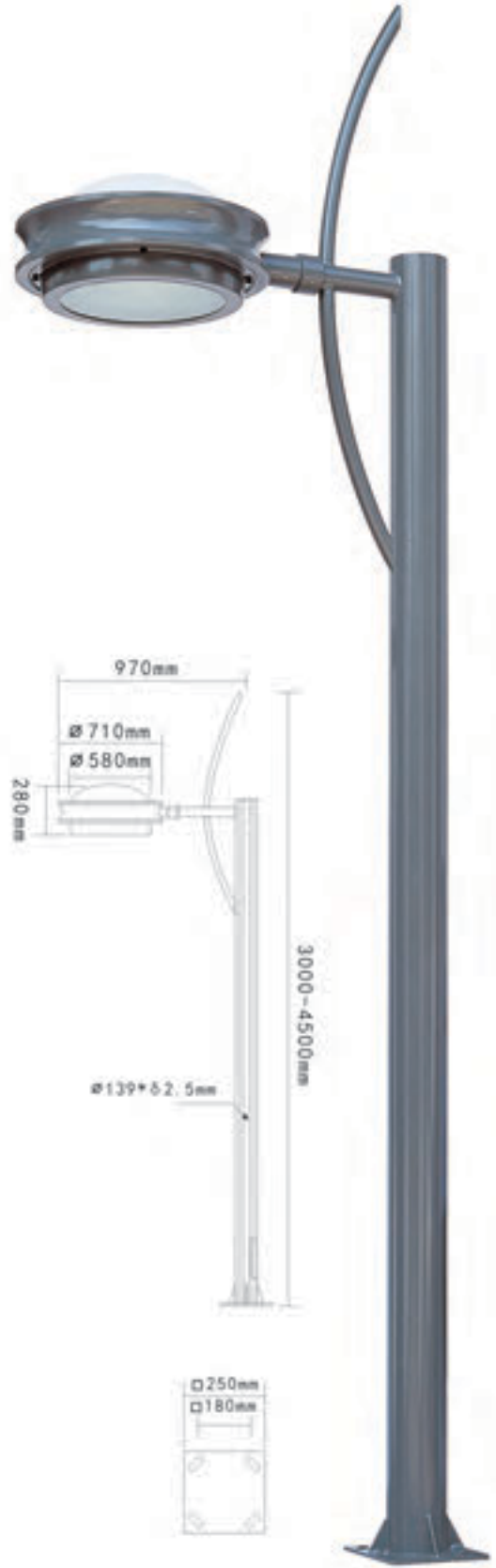

OLO-RHT397

Product Description:

Material: Extruded aluminum fitting, PC diffuser, With anodized high pure brightened aluminum reflector

Suitable lamp: LED 40W

Finish: Corrosion resistant treatment then with UV-proof powder coating

IP Rate: 65

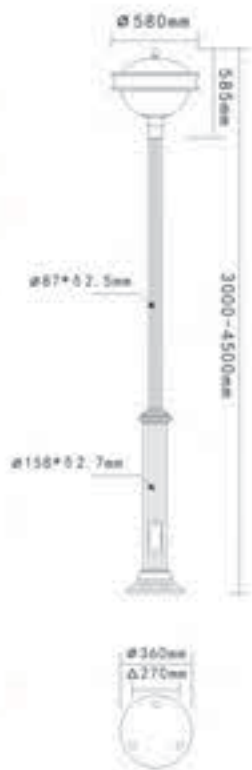

OLO-RHT403

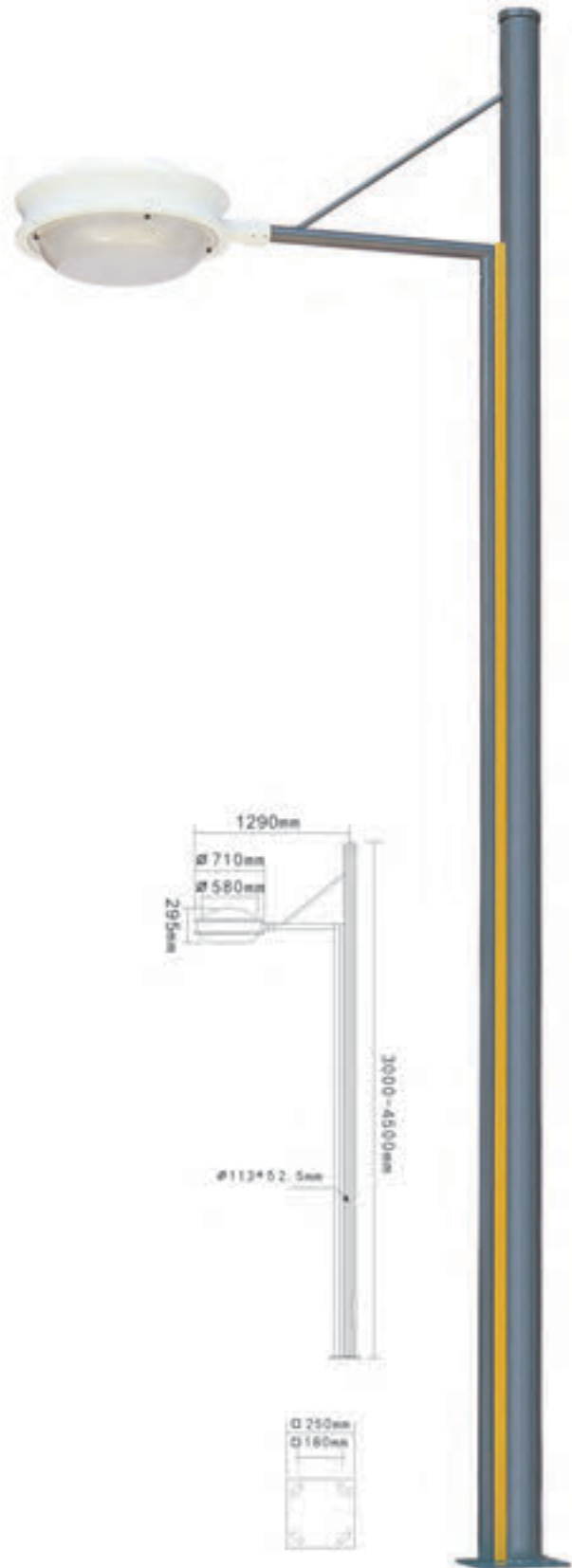

OLO-RHT402

Product Description:

Material: Extruded aluminum fitting, PC diffuser, With anodized high pure brightened aluminum reflector

Suitable lamp: LED 40W

Finish: Corrosion resistant treatment then with UV-proof powder coating

IP Rate: 65

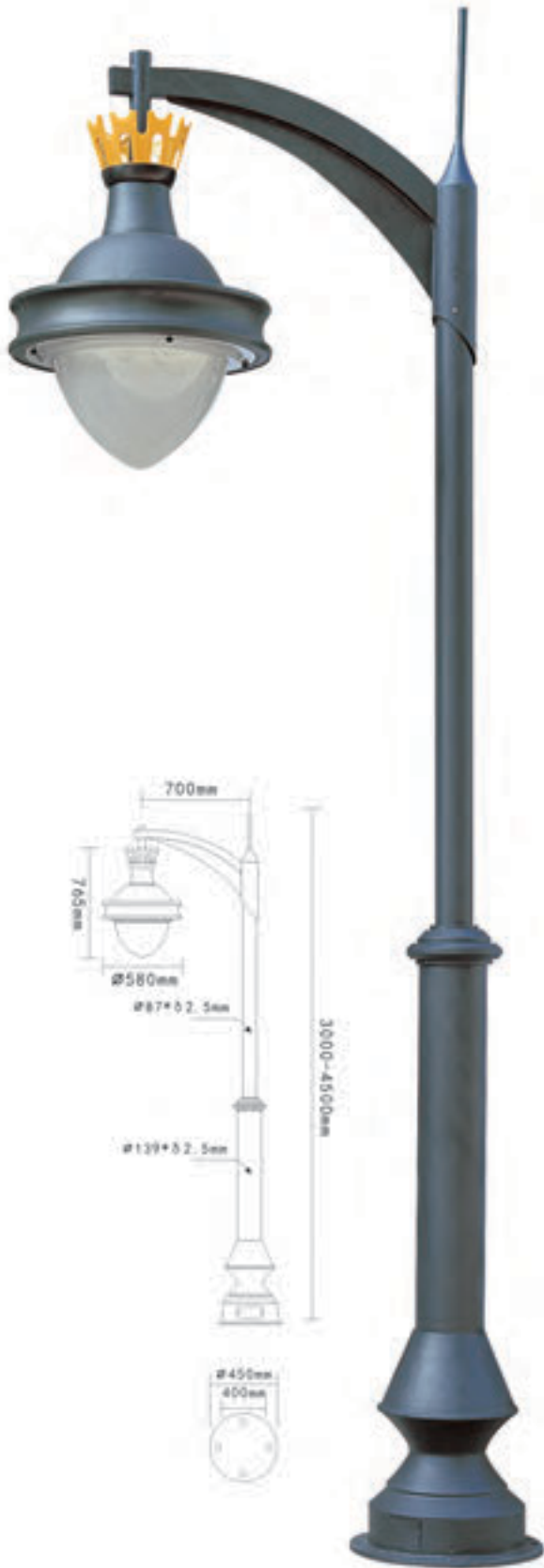

OLO-RHT406

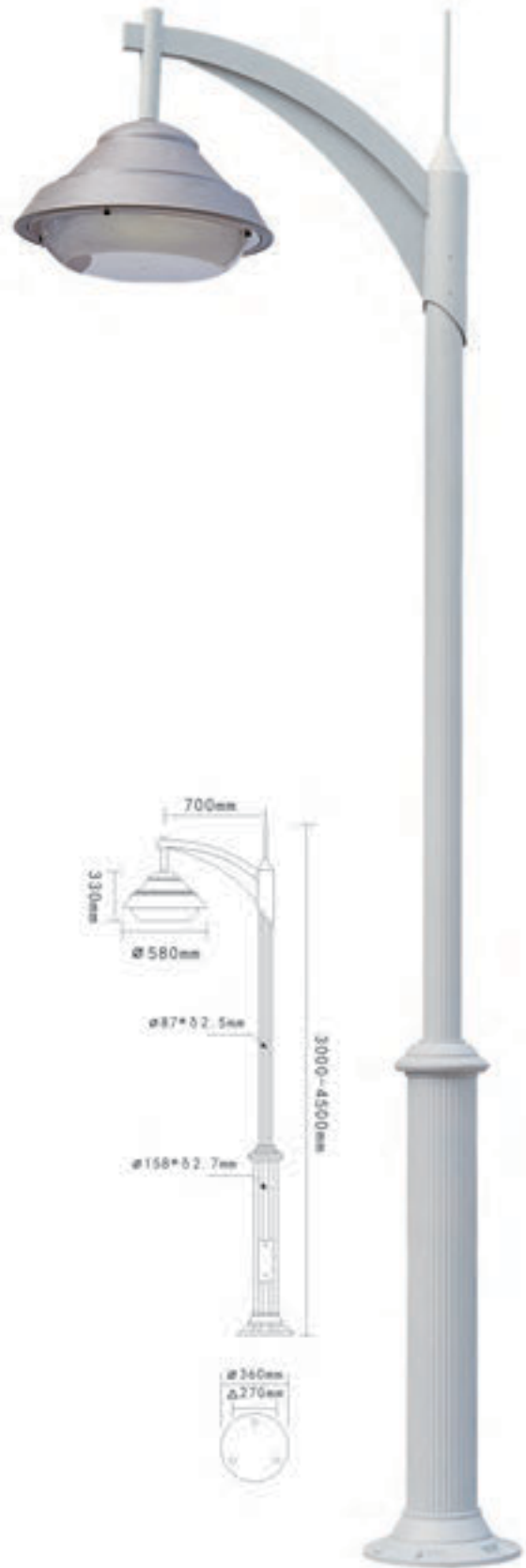

OLO-RHT407

Product Description:

Material: Extruded aluminum fitting, PC diffuser, With anodized high pure brightened aluminum reflector

Suitable lamp: LED 40W

Finish: Corrosion resistant treatment then with UV-proof powder coating

IP Rate: 65

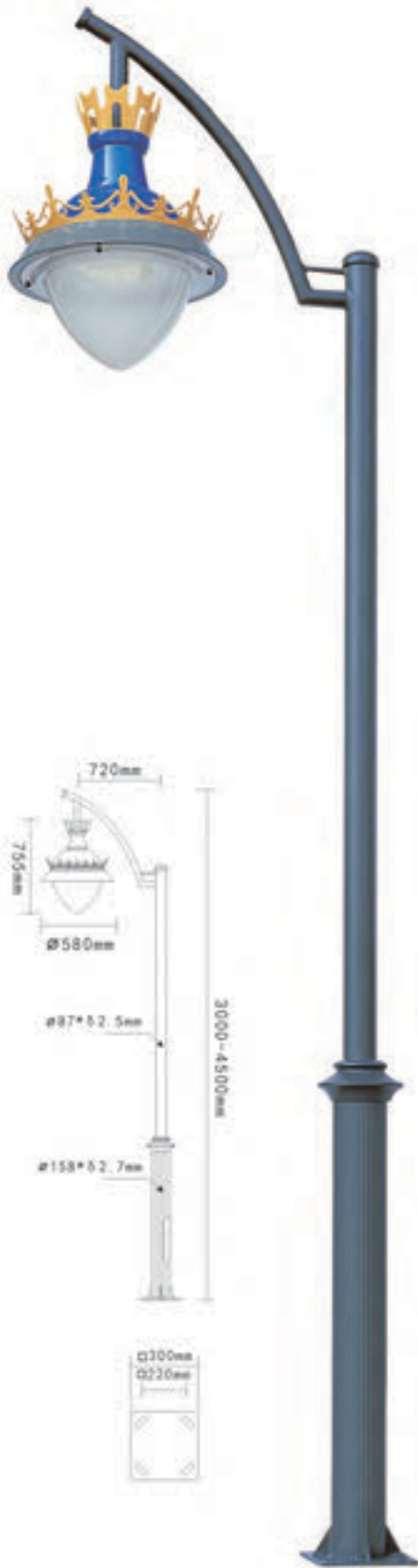

OLO-RHT410

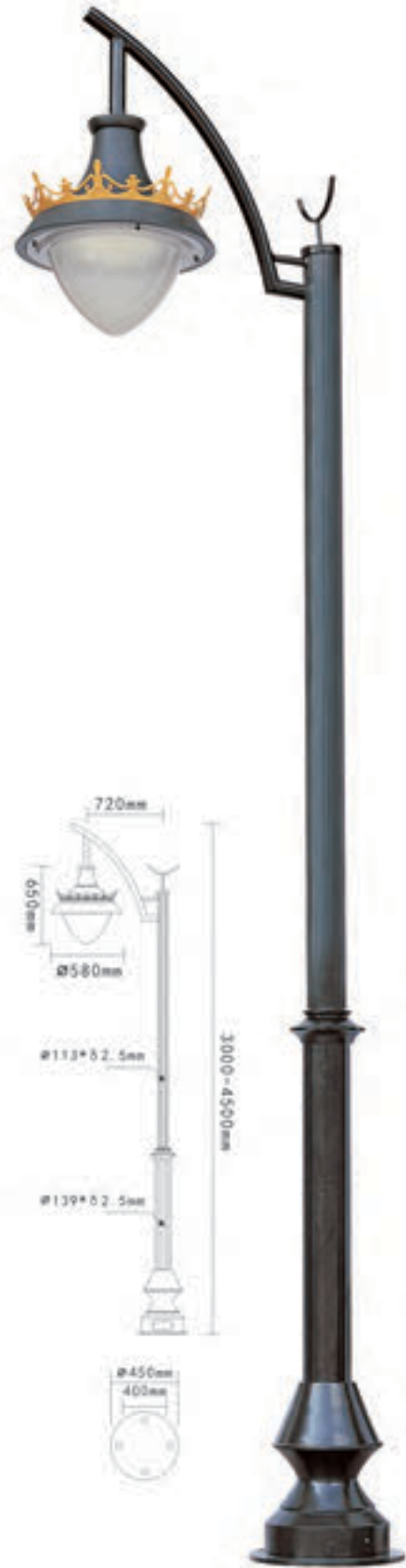

OLO-RHT411

Product Description:

Material: Extruded aluminum fitting, PC diffuser, With anodized high pure brightened aluminum reflector

Suitable lamp: LED 40W

Finish: Corrosion resistant treatment then with UV-proof powder coating

IP Rate: 65

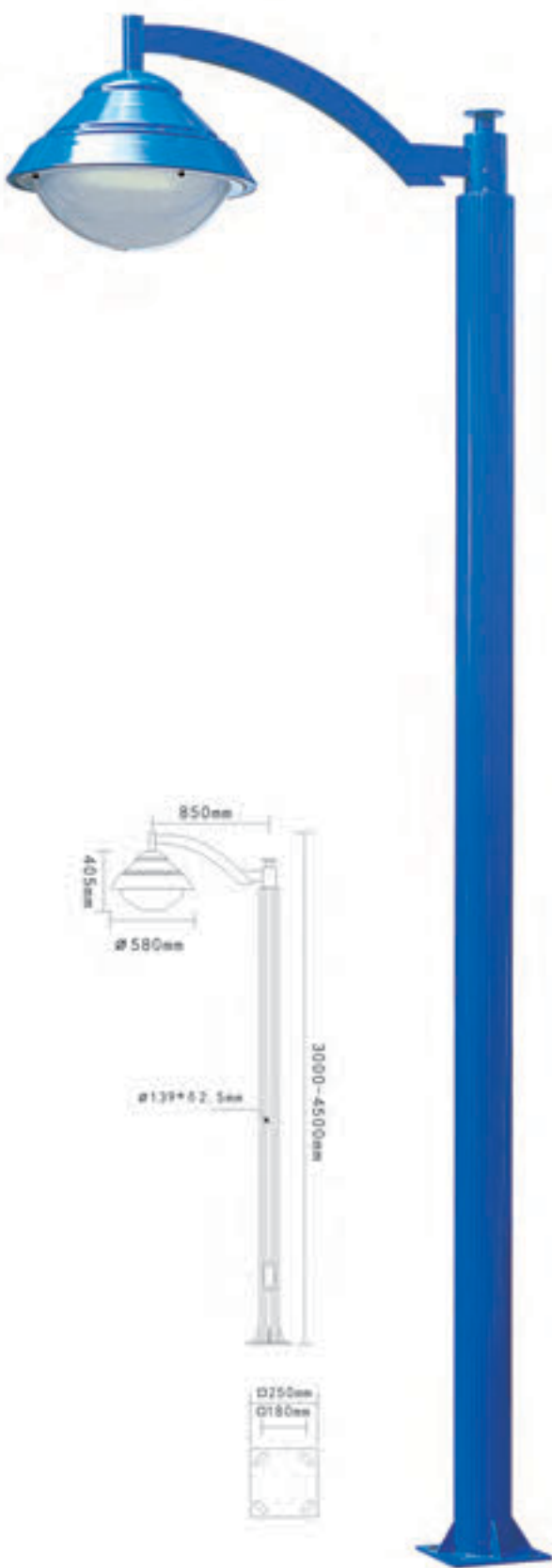

OLO-RHT414

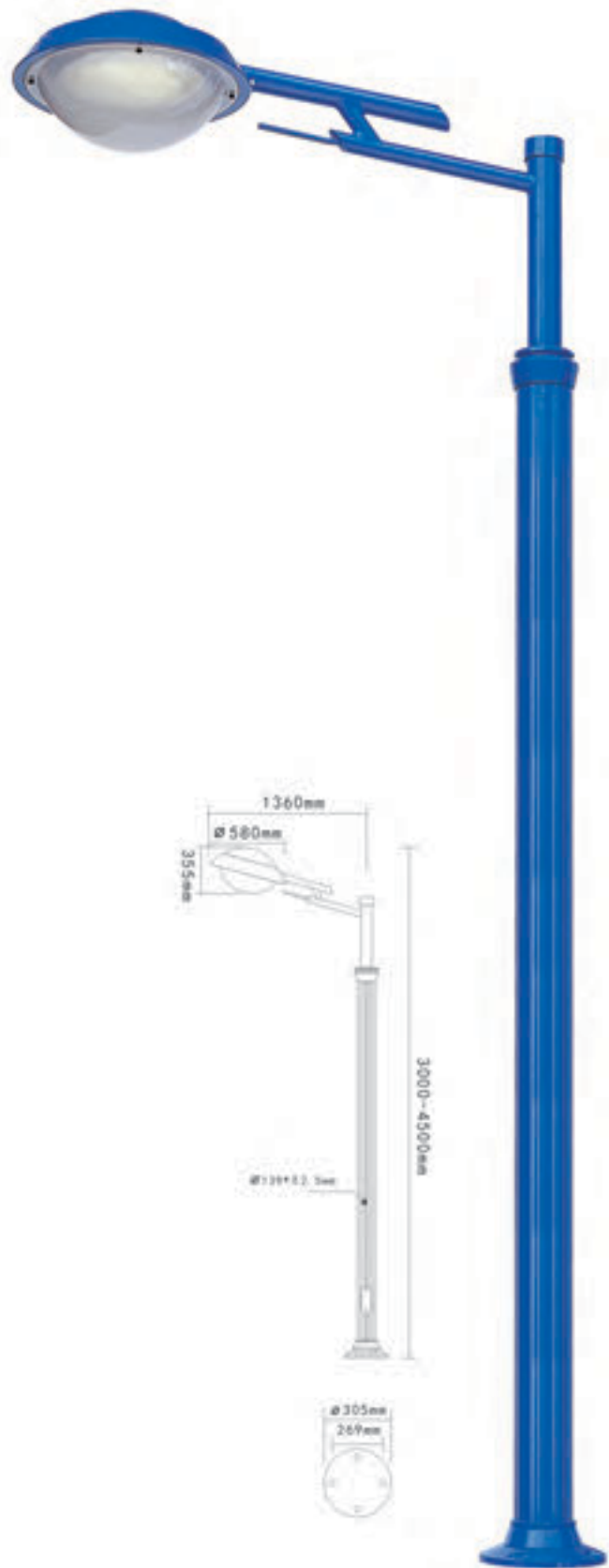

OLO-RHT415

Product Description:

Material: Extruded aluminum fitting, PC diffuser. With anodized high pure brightened aluminum reflector

Suitable lamp: LED 40W

Finish: Corrosion resistant treatment then with UV-proof powder coating

IP Rate: 65

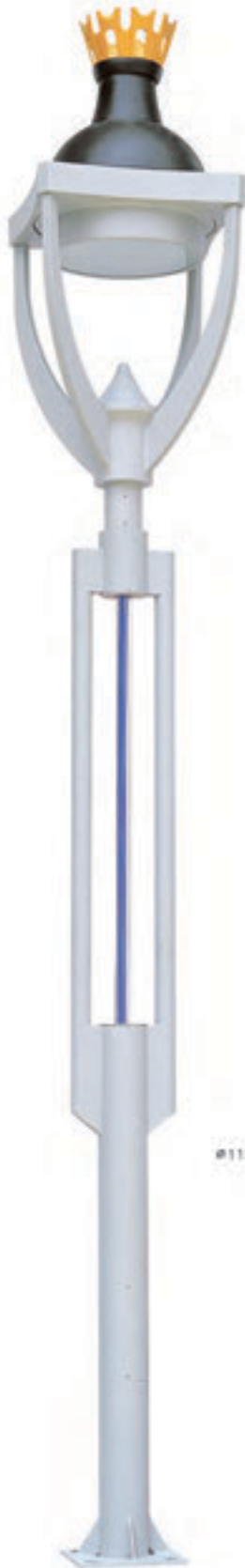

OLO-RHT419

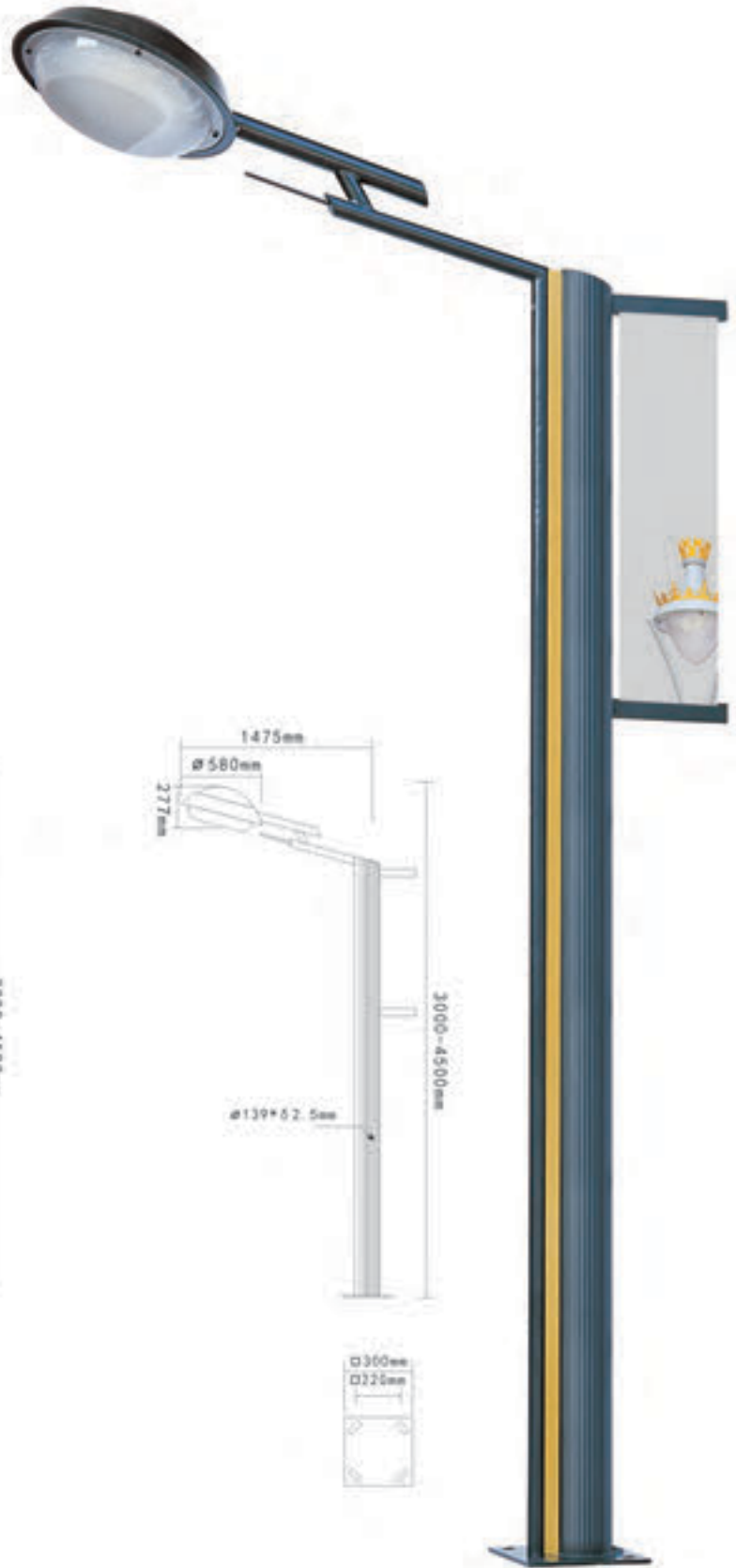
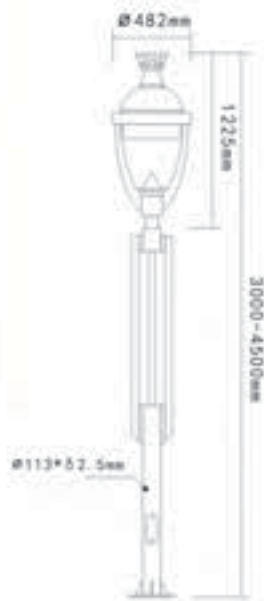

OLO-RHT418



Product Description:

Material: Extruded aluminum fitting, PC diffuser. With anodized high pure brightened aluminum reflector

Suitable lamp: LED 40W

Finish: Corrosion resistant treatment then with UV-proof powder coating

IP Rate: 65

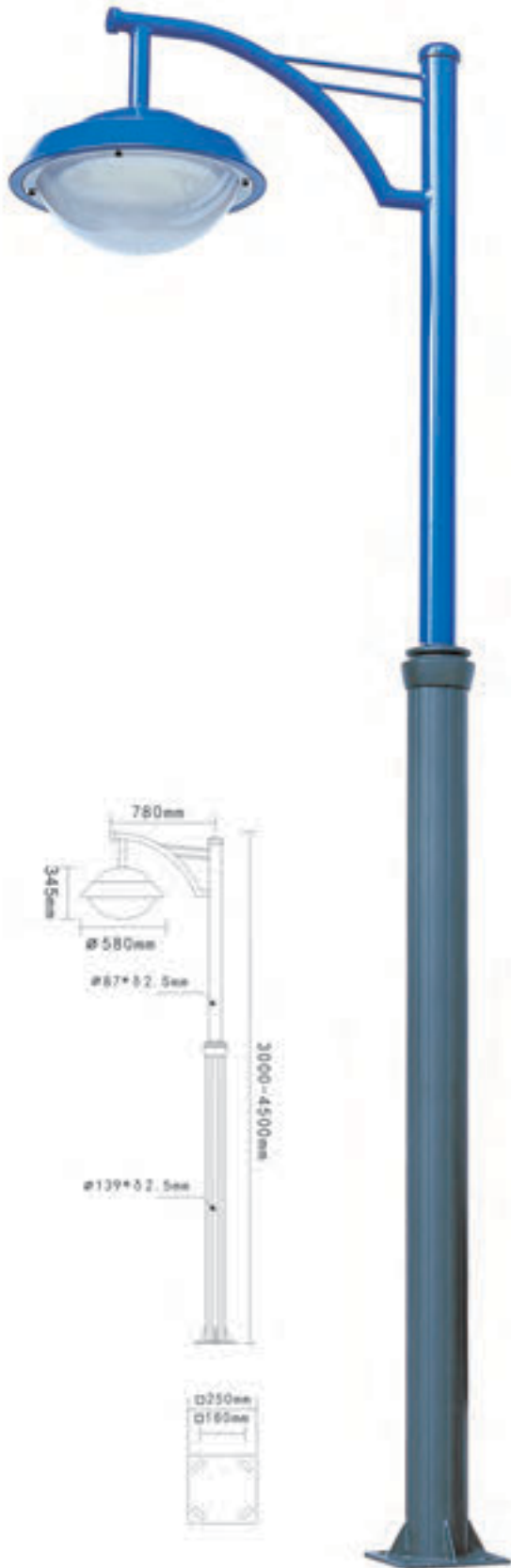

OLO-RHT420

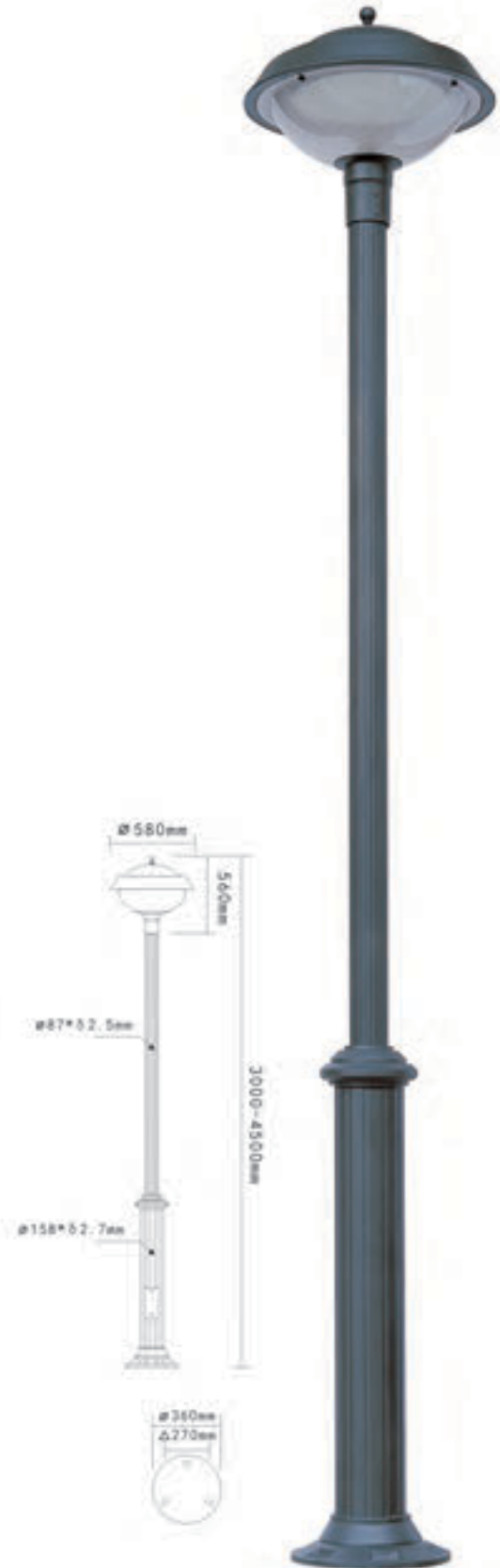

OLO-RHT421



Product Description:

Material: Extruded aluminum fitting, PC diffuser, With anodized high pure brightened aluminum reflector

Suitable lamp: LED 40W

Finish: Corrosion resistant treatment then with UV-proof powder coating

IP Rate: 65

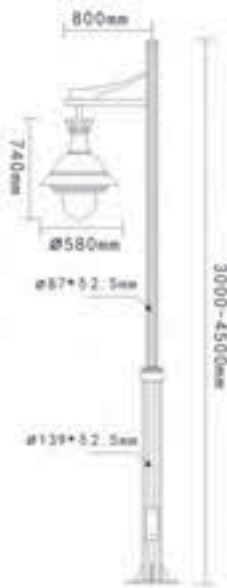

OLO-RHT428



OLO-RHT429

Product Description:

Material: Extruded aluminum fitting, PC diffuser, With anodized high pure brightened aluminum reflector

Suitable lamp: LED 40W

Finish: Corrosion resistant treatment then with UV-proof powder coating

IP Rate: 65



OLO-RHT432

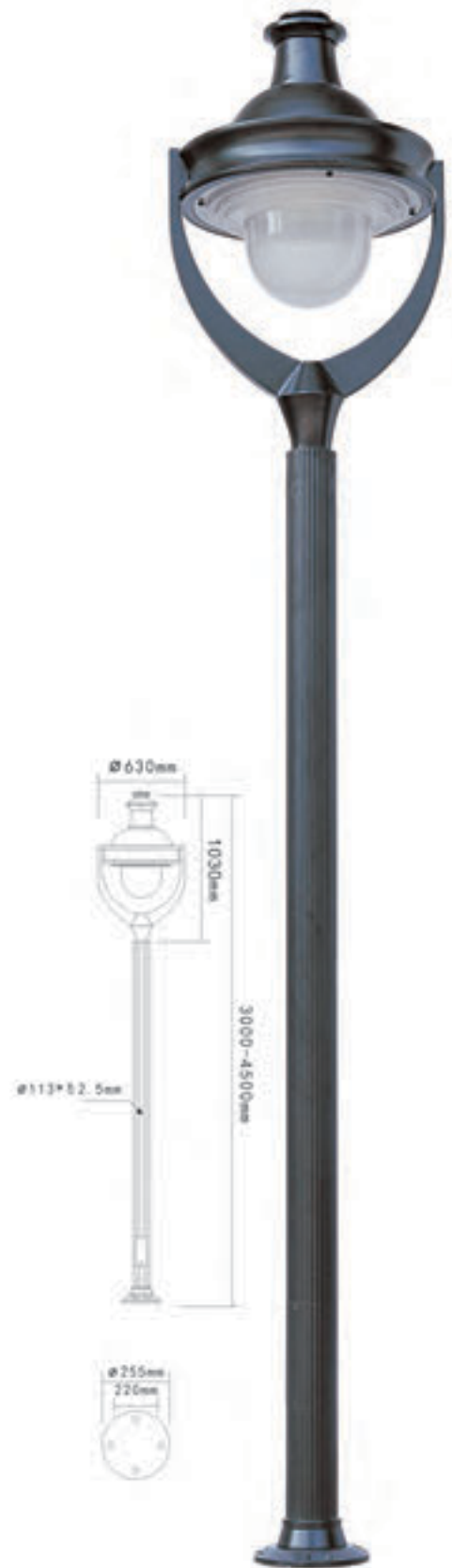

OLO-RHT433

Product Description:

Material: Extruded aluminum fitting, PC diffuser, With anodized high pure brightened aluminum reflector

Suitable lamp: LED 40W

Finish: Corrosion resistant treatment then with UV-proof powder coating

IP Rate: 65

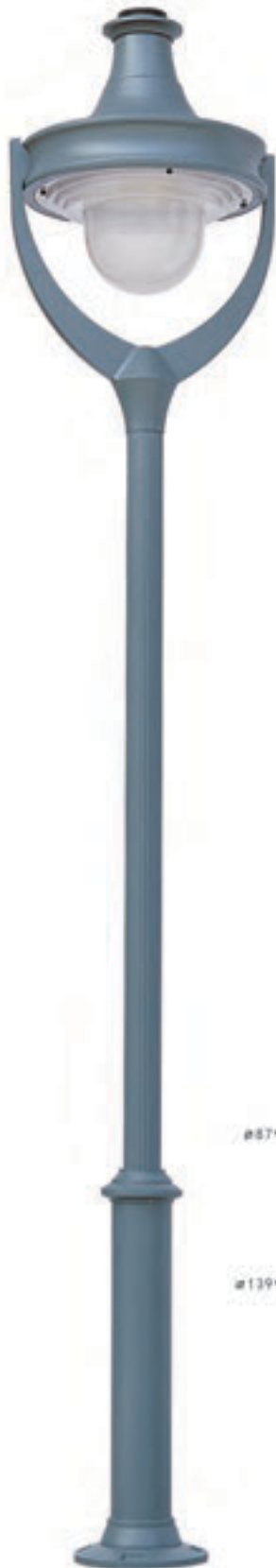

OLO-RHT438

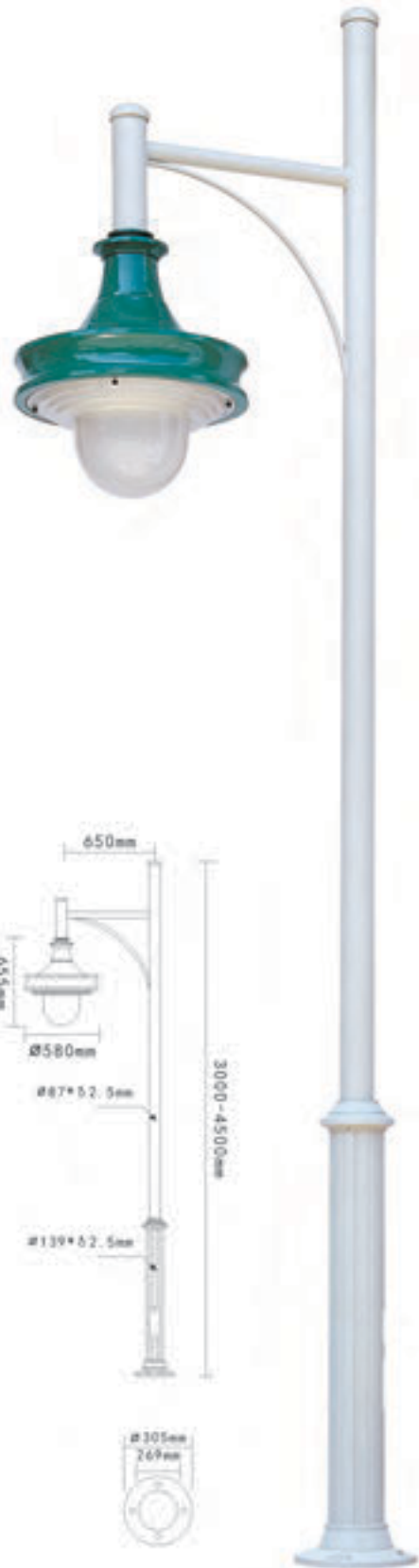

OLO-RHT439

Product Description:

Material: Extruded aluminum fitting, PC diffuser, With anodized high pure brightened aluminum reflector

Suitable lamp: LED 40W

Finish: Corrosion resistant treatment then with UV-proof powder coating

IP Rate: 65

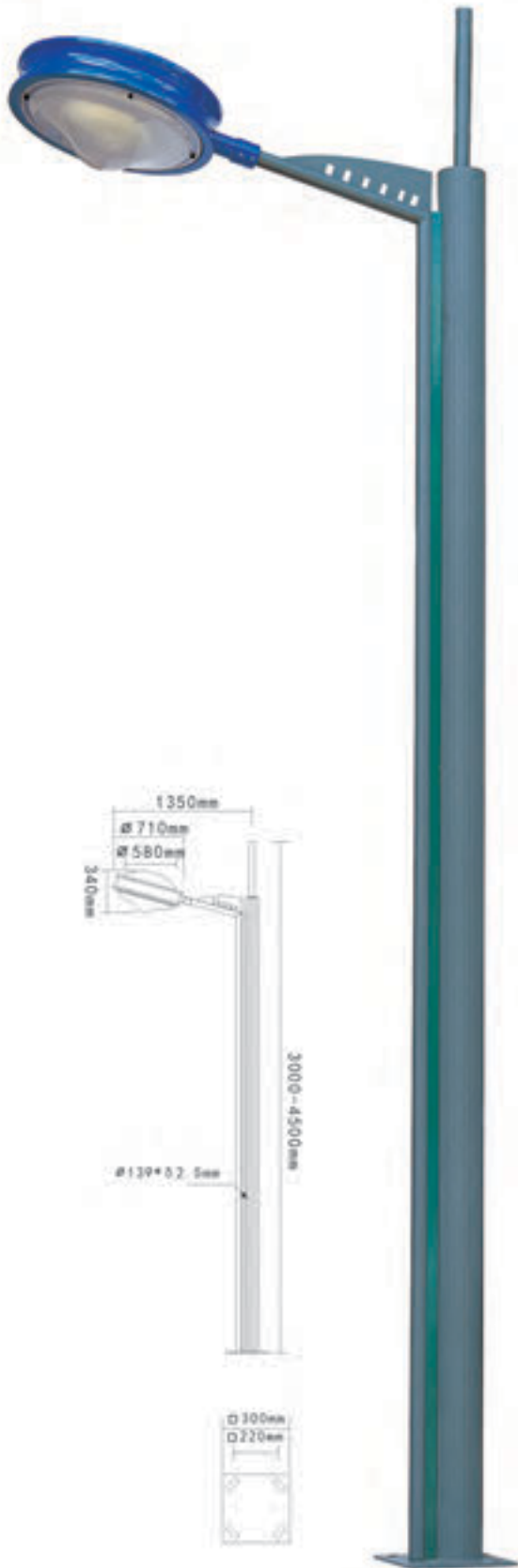

OLO-RHT440

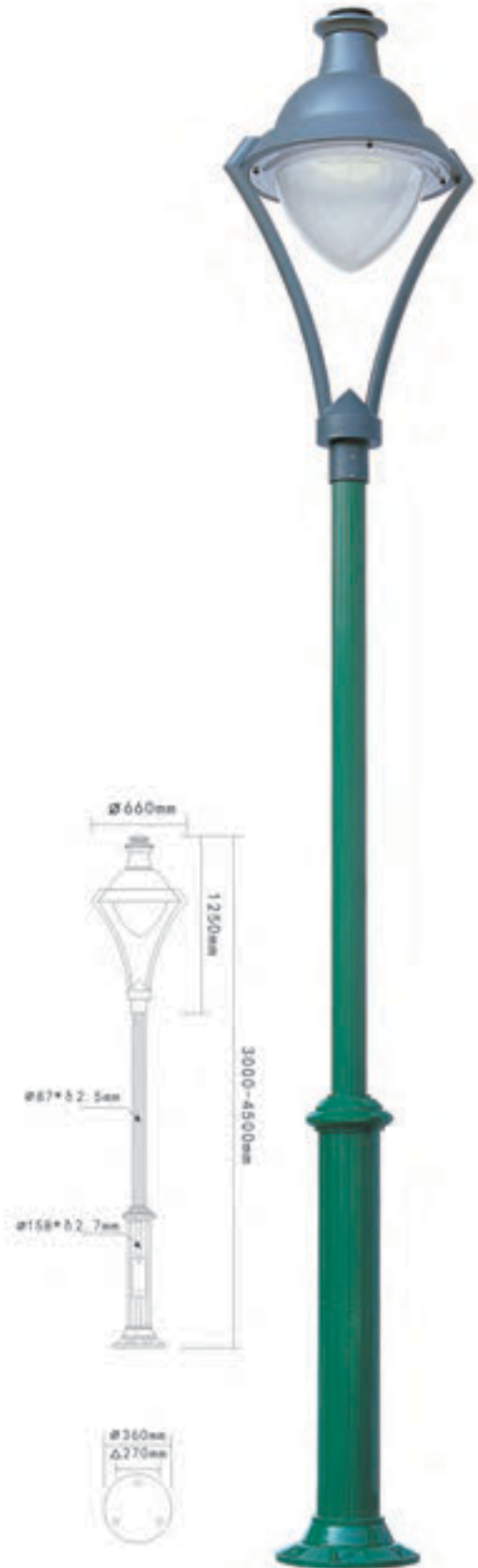

OLO-RHT441

Product Description:

Material: Extruded aluminum fitting, PC diffuser, With anodized high pure brightened aluminum reflector

Suitable lamp: LED 40W

Finish: Corrosion resistant treatment then with UV-proof powder coating

IP Rate: 65

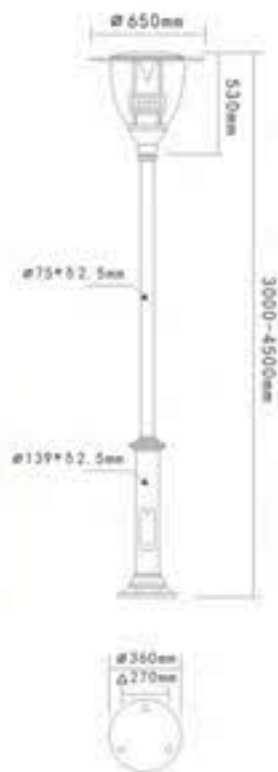

OLO-RHT444

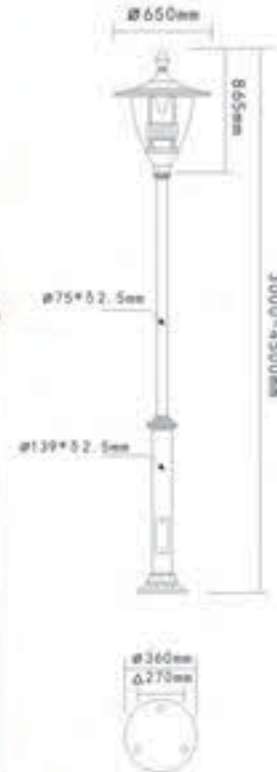

OLO-RHT445

Product Description:

Material: Extruded aluminum fitting, PC diffuser, With anodized high pure brightened aluminum reflector

Suitable lamp: LED 40W

Finish: Corrosion resistant treatment then with UV-proof powder coating

IP Rate: 65



OLO-RHT450

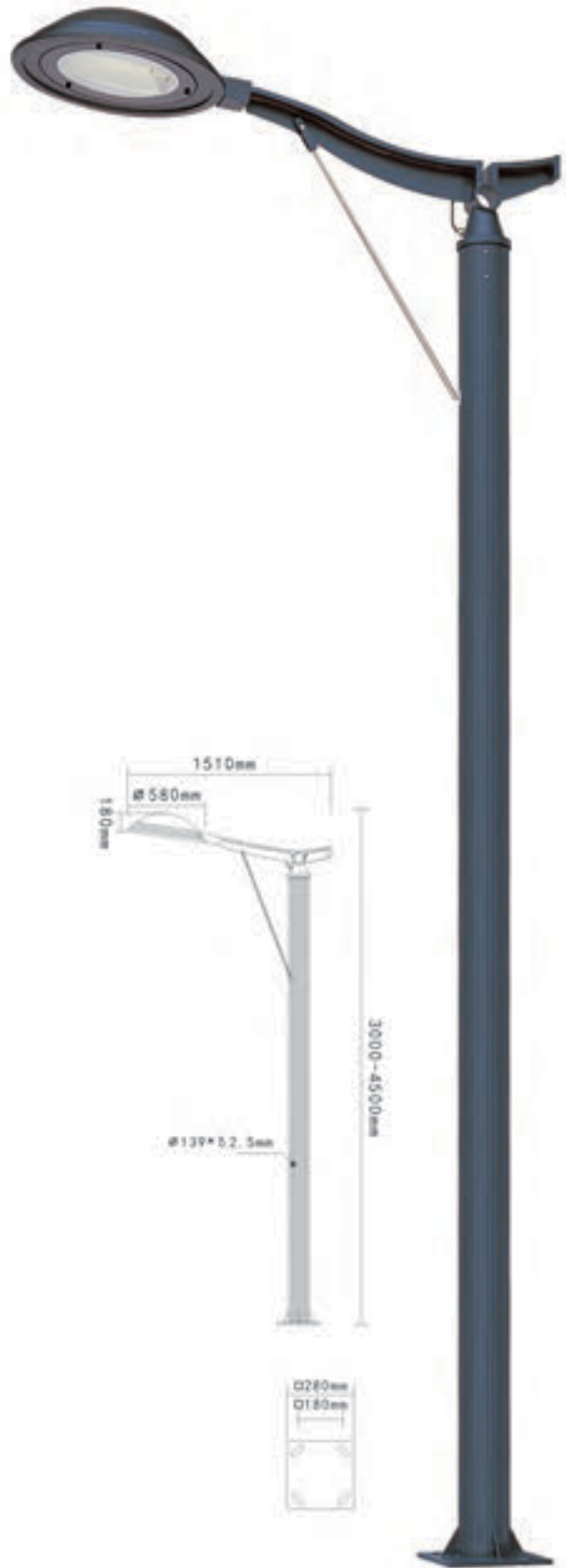

OLO-RHT451

Product Description:

Material: Extruded aluminum fitting, PC diffuser, With anodized high pure brightened aluminum reflector

Suitable lamp: LED 40W

Finish: Corrosion resistant treatment then with UV-proof powder coating

IP Rate: 65



OLO-RHT454

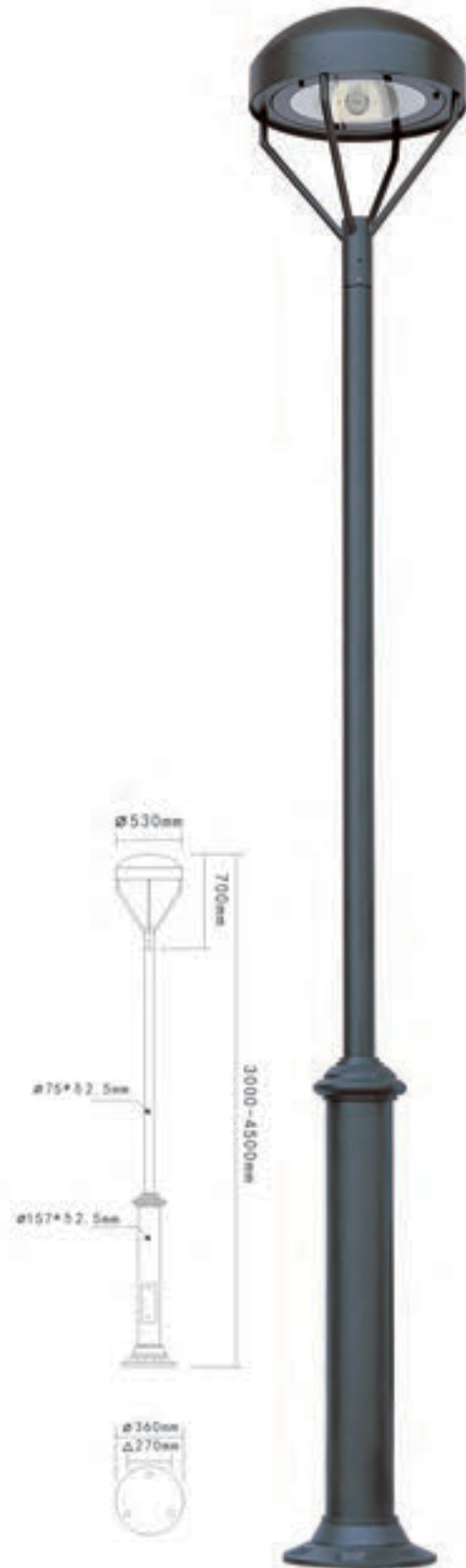

OLO-RHT455

Product Description:

Material: Extruded aluminum fitting, PC diffuser. With anodized high pure brightened aluminum reflector

Suitable lamp: LED 40W

Finish: Corrosion resistant treatment then with UV-proof powder coating

IP Rate: 65



OLO-RHT458



OLO-RHT459

Product Description:

Material: Extruded aluminum fitting, PC diffuser, With anodized high pure brightened aluminum reflector

Suitable lamp: LED 40W

Finish: Corrosion resistant treatment then with UV-proof powder coating

IP Rate: 65



OLO-RHT462

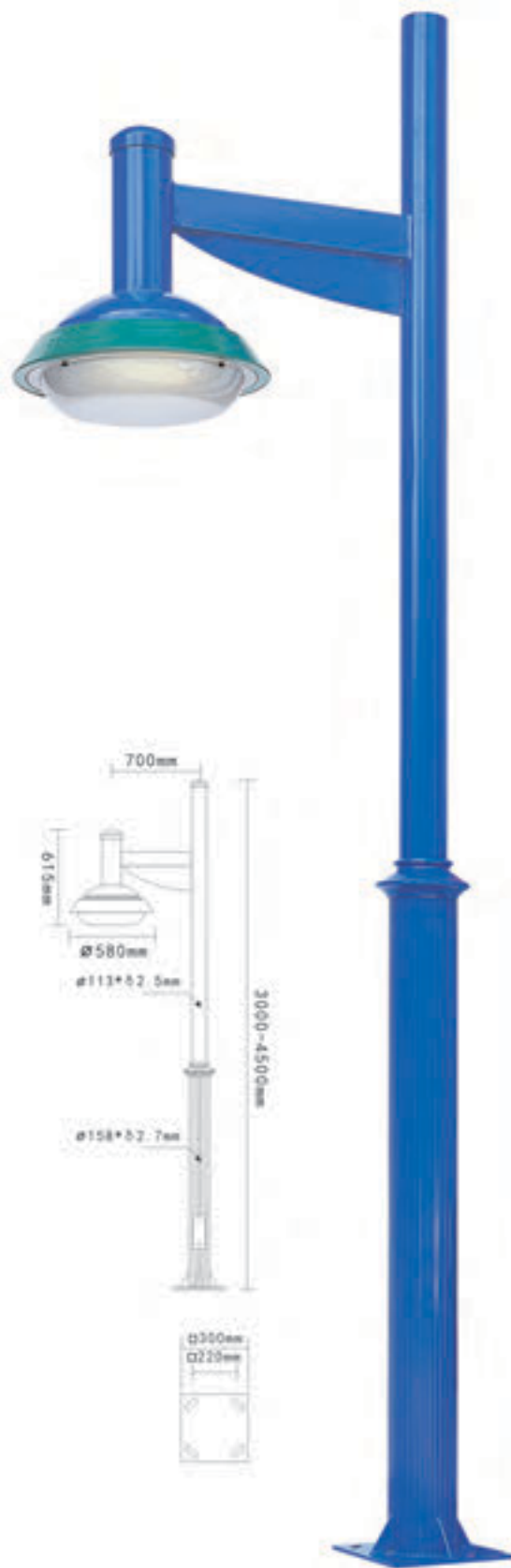

OLO-RHT463

Product Description:

Material: Extruded aluminum fitting, PC diffuser, With anodized high pure brightened aluminum reflector

Suitable lamp: LED 40W

Finish: Corrosion resistant treatment then with UV-proof powder coating

IP Rate: 65



OLO-RHT466

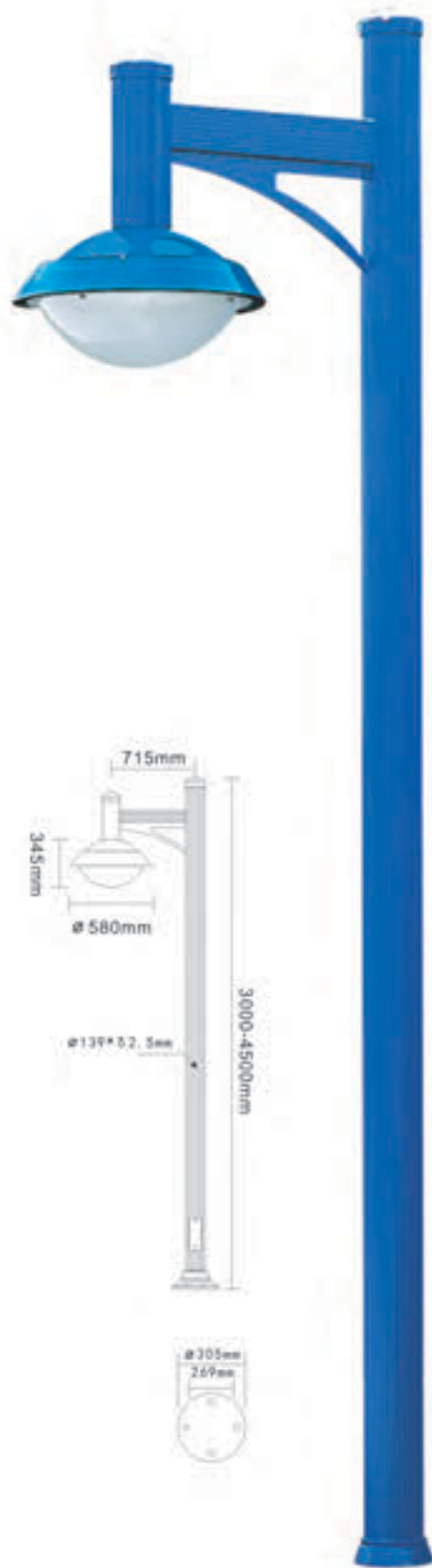

OLO-RHT467

Product Description:

Material: Extruded aluminum fitting, PC diffuser. With anodized high pure brightened aluminum reflector

Suitable lamp: LED 40W

Finish: Corrosion resistant treatment then with UV-proof powder coating

IP Rate: 65



OLO-RHT470



OLO-RHT471

Product Description:

Material: Extruded aluminum fitting, PC diffuser. With anodized high pure brightened aluminum reflector

Suitable lamp: LED 40W

Finish: Corrosion resistant treatment then with UV-proof powder coating

IP Rate: 65



OLO-RHT426

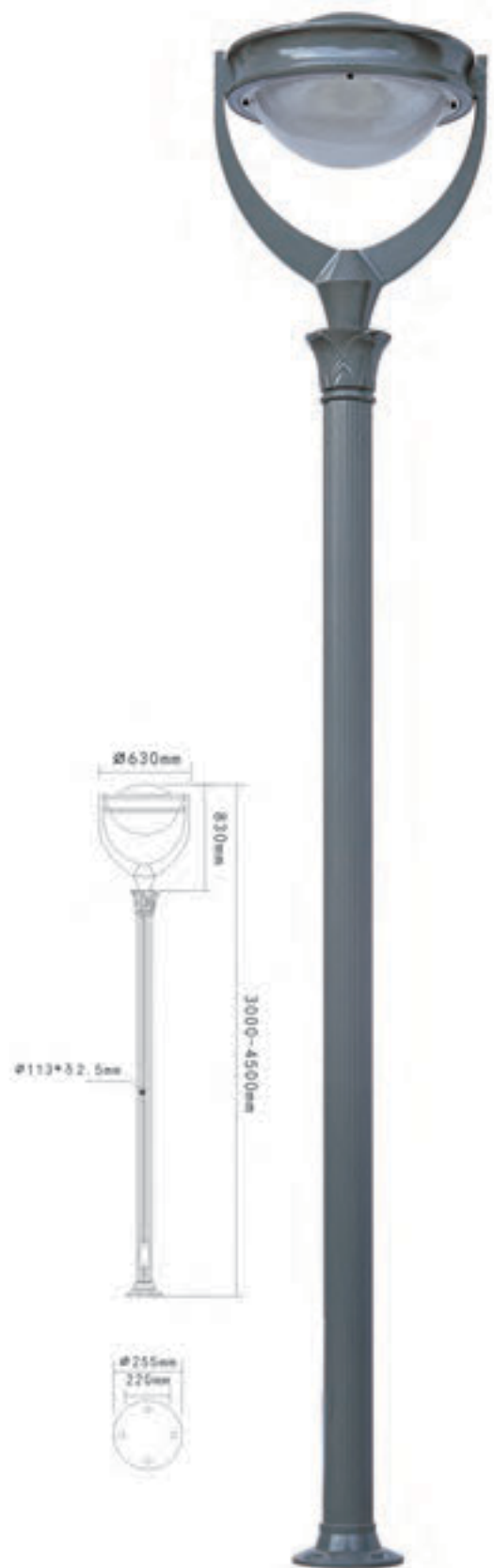

OLO-RHT427



Product Description:

Material: Extruded aluminum fitting, PC diffuser, With anodized high pure brightened aluminum reflector

Suitable lamp: LED 40W

Finish: Corrosion resistant treatment then with UV-proof powder coating

IP Rate: 65

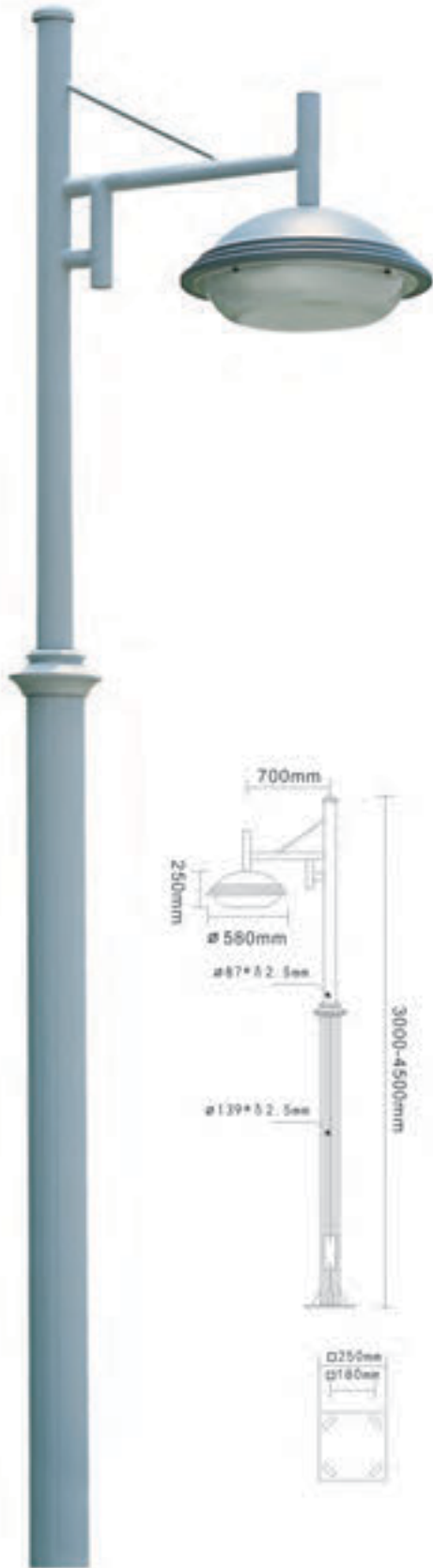

OLO-RHT472

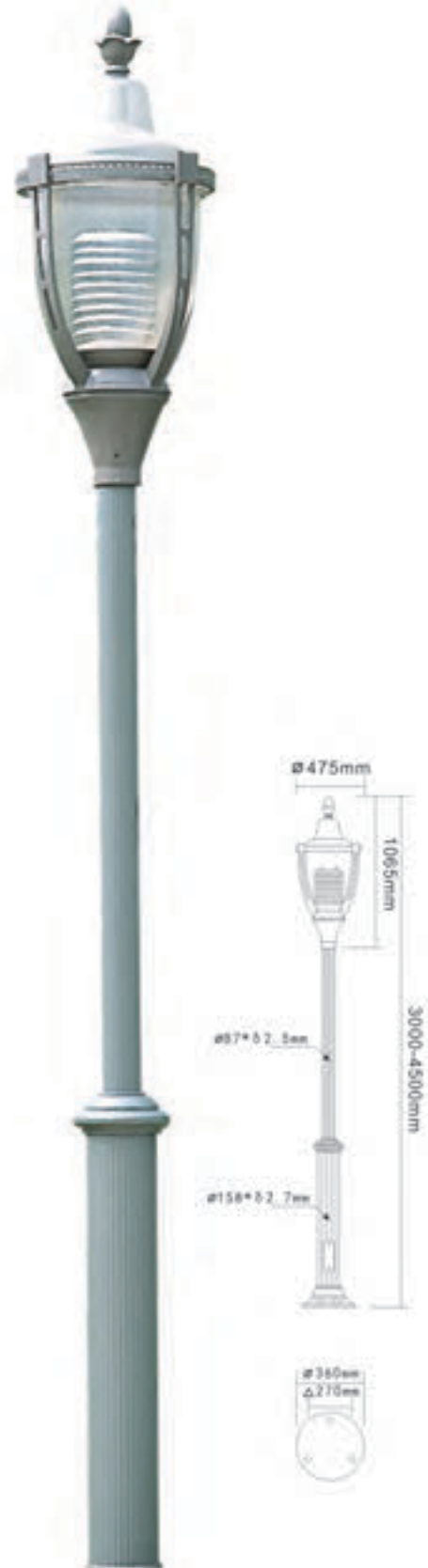

OLO-RHT473

Product Description:

Material: Extruded aluminum fitting, PC diffuser. With anodized high pure brightened aluminum reflector

Suitable lamp: LED 40W

Finish: Corrosion resistant treatment then with UV-proof powder coating

IP Rate: 65



OLO-RHT304



OLO-RHT303





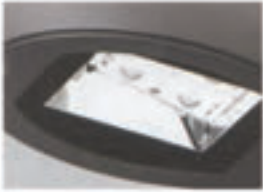

HOUSING

Cast aluminum, Alu reflector, Stainless steel screws
Silicon seal gaskets

DIFFUSER

Clear tempered glass

COLOR TEMPERATURE

3000/6000K

FINISH

Texture dark gray or silver powdercoat finish

PROTECTION CLASS

IP 65

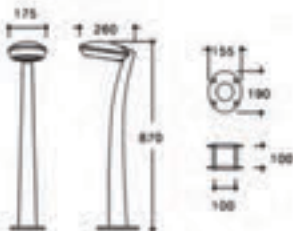

LAMP

OLO-DH-8320 LED 5/10W 90-260V 50/60Hz

OLO-DH-8320

FREE

LED Lawn Light





OLO-DH-8382

OLO-DH-8383

HOUSING

Cast and extruded aluminum, Alu reflector
Stainless steel screws, Silicon seal gaskets

DIFFUSER

OLO-DH-8382, OLO-DH-8383 Opal acrylic
OLO-DH-8385 Clear tempered glass

COLOR TEMPERATURE

OLO-DH-8382, OLO-DH-8383 3000K, 5700K
OLO-DH-8385 3000K, 4000K

FINISH

Texture dark gray or silver powdercoat finish

PROTECTION CLASS

IP 65

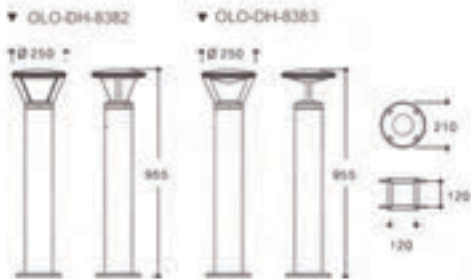

LAMP
OLO-DH-8382 LED 5W 90-260V 50/60Hz



LAMP
OLO-DH-8383 LED 5W 90-260V 50/60Hz



OLO-DH-8382

OLO-DH-8383



HOUSING
 Cast and extruded aluminum, Stainless steel screws
 Silicon seal gaskets

DIFFUSER
 Opal and clear polycarbonate

FINISH
 Texture dark gray or silver powdercoat finish

PROTECTION CLASS
 IP 65

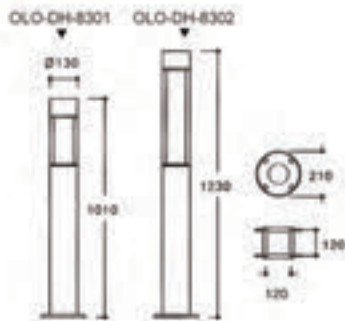

LAMP
OLO-DH-8301 LED 5W 90-260V 50/60Hz



LAMP
OLO-DH-8302 LED 5W 90-260V 50/60Hz



OLO-DH-8301

OLO-DH-8302



LED Lawn Light

HOUSING
 Cast and extruded aluminum, Stainless steel screws
 Silicon seal gaskets

DIFFUSER
 Opal acrylic

FINISH
 Texture dark gray or silver powdercoat finish

PROTECTION CLASS
 IP 54

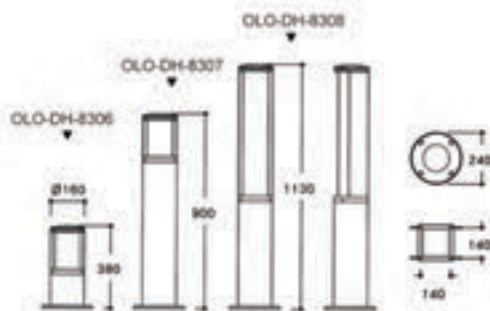

	LAMP	HEIGHT
OLO-DH-8306	LED 5W 90-260V 50/60Hz	380 mm
OLO-DH-8307	LED 5W 90-260V 50/60Hz	900 mm
OLO-DH-8308	LED 5W 90-260V 50/60Hz	1130 mm



OLO-DH-8306

OLO-DH-8308



HOUSING

Cast and extruded aluminum, Stainless steel screws
Silicon seal gaskets

DIFFUSER

Opal polycarbonate

COLOR TEMPERATURE

3000/6000K

FINISH

Texture dark gray or silver powdercoat finish

PROTECTION CLASS

IP 54

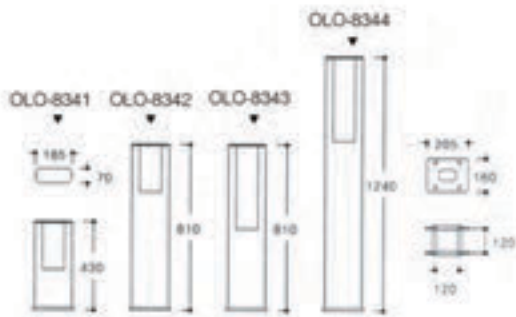

	LAMP	HEIGHT
OLO-8341	LED 5W 90-260V 50/60Hz	430 mm
OLO-8342	LED 5W 90-260V 50/60Hz	810 mm
OLO-8343	LED 5W 90-260V 50/60Hz	810 mm
OLO-8344	LED 5W 90-260V 50/60Hz	1240 mm



LED Lawn Light

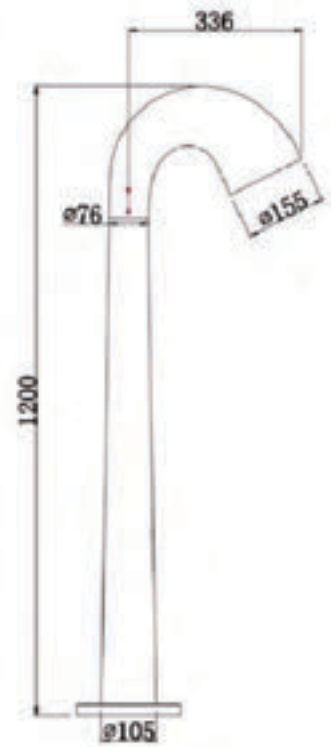

- Cast aluminum body
- Glass/PMMA
- 3000/6000K 90-260V 50/60Hz
- LED 5W





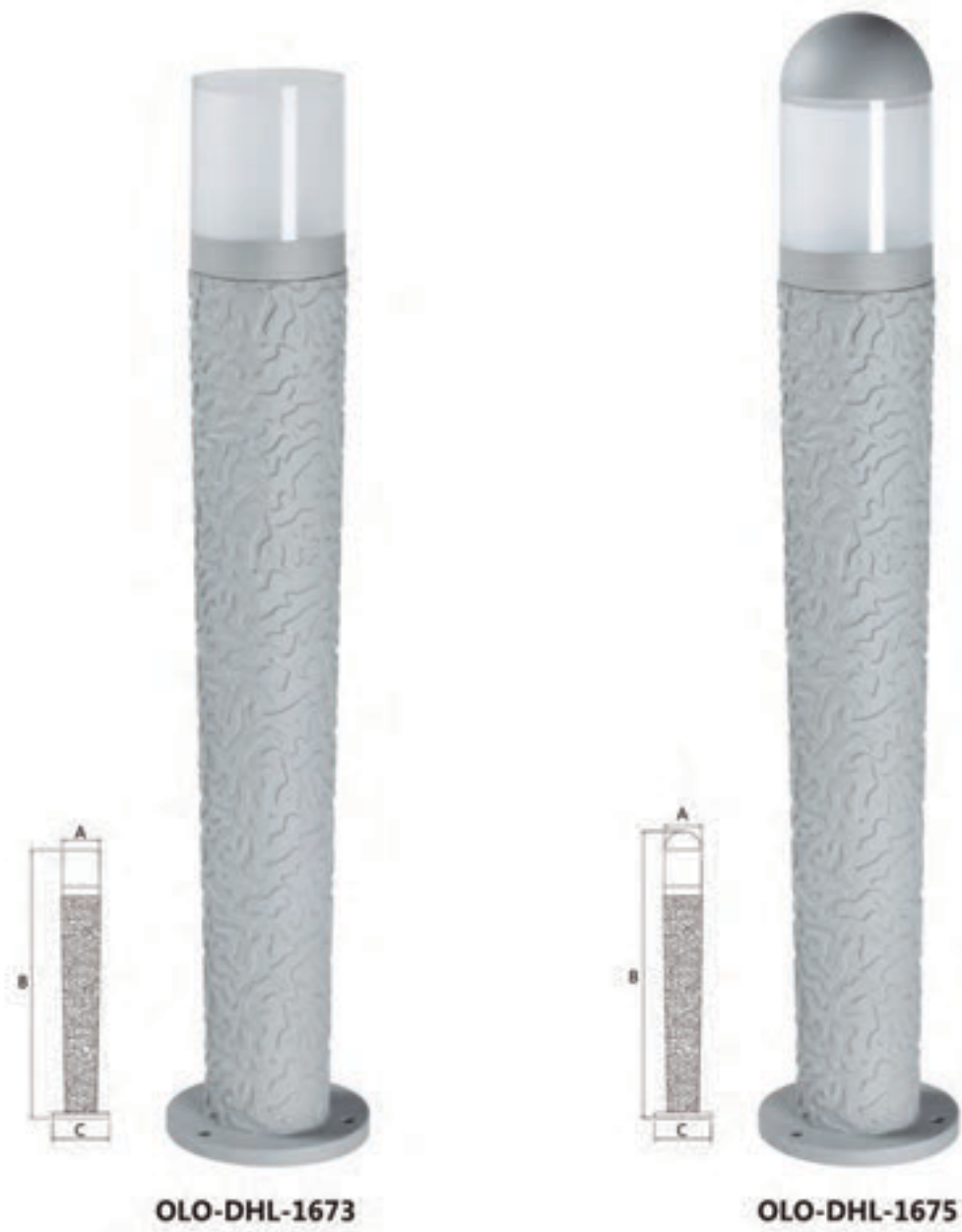

OLO-DHL-1673

OLO-DHL-1675

Item No.	A	B	C	Lamp
OLO-DHL-1673	∅113	800	∅170	LED COB 5Wx1
OLO-DHL-1674	∅113	800	∅170	E27x1
OLO-DHL-1675	∅113	855	∅170	LED COB 5Wx1
OLO-DHL-1676	∅113	855	∅170	E27x1

- Cast aluminum body
- PMMA
- 3000/6000K 90-260V 50/60Hz







OLO-DHL-1677



OLO-DHL-1679

Item No.	A	B	C	Lamp
OLO-DHL-1677	∅140	900	∅170	LED COB 5Wx1
OLO-DHL-1678	∅140	900	∅170	E27x1
OLO-DHL-1679	∅140	965	∅170	LED COB 5Wx1
OLO-DHL-1680	∅140	965	∅170	E27x1

- Cast aluminum body
- PMMA
- 3000/6000K 90-260V 50/60Hz





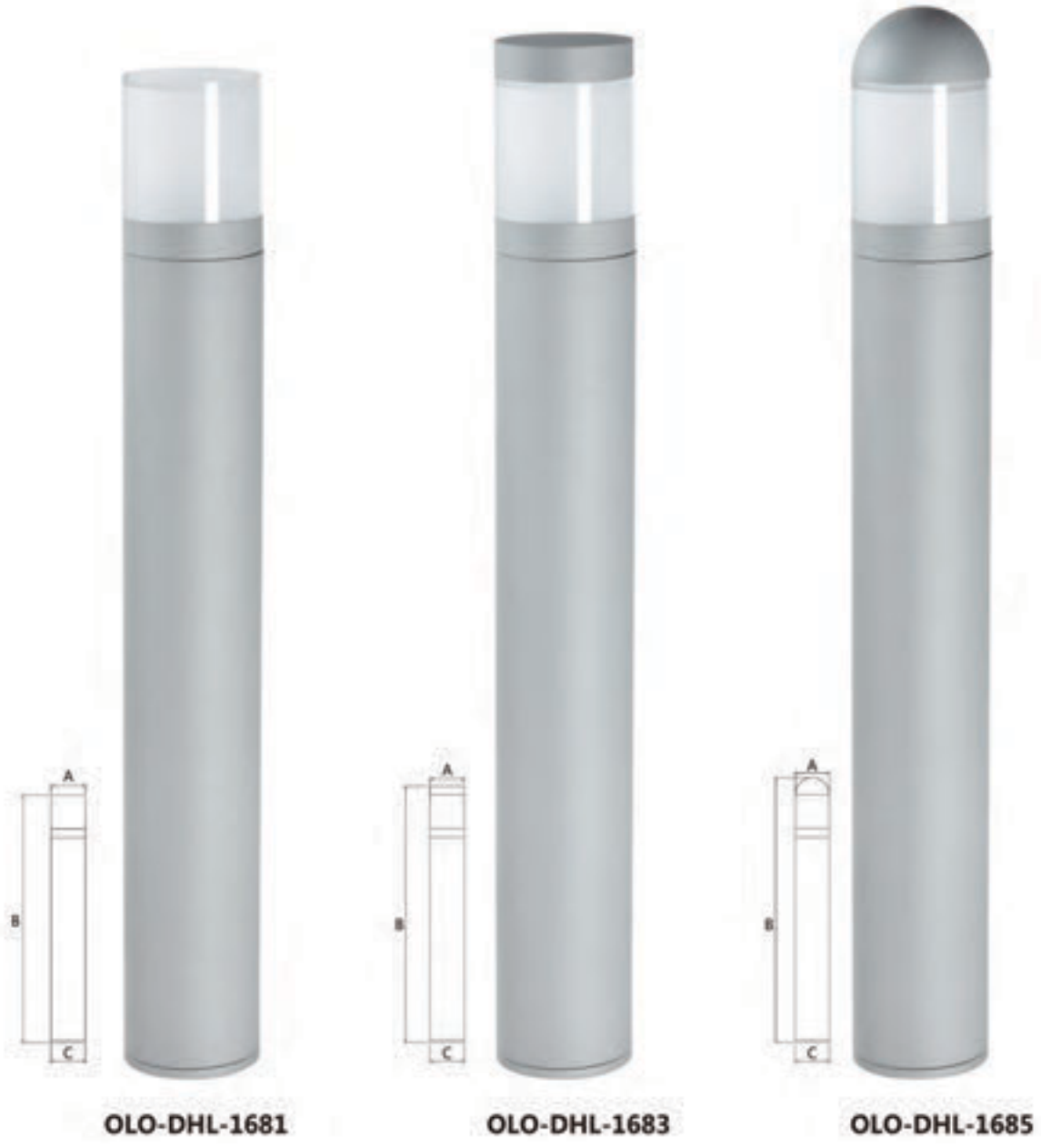

OLO-DHL-1681

OLO-DHL-1683

OLO-DHL-1685

Item No.	A	B	C	Lamp
OLO-DHL-1681	∅113	800	∅113	LED COB 5Wx1
OLO-DHL-1682	∅113	800	∅113	E27x1
OLO-DHL-1683	∅113	828	∅113	LED COB 5Wx1
OLO-DHL-1684	∅113	828	∅113	E27x1
OLO-DHL-1685	∅113	855	∅113	LED COB 5Wx1
OLO-DHL-1686	∅113	855	∅113	E27x1

- Cast aluminum body
- PMMA
- 3000/6000K 90-260V 50/60Hz







OLO-DHL-1687

OLO-DHL-1689

OLO-DHL-1691

Item No.	A	B	C	Lamp
OLO-DHL-1687	∅113	800	∅113	LED COB 5Wx1
OLO-DHL-1688	∅113	800	∅113	E27x1
OLO-DHL-1689	∅113	828	∅113	LED COB 5Wx1
OLO-DHL-1690	∅113	828	∅113	E27x1
OLO-DHL-1691	∅113	855	∅113	LED COB 5Wx1
OLO-DHL-1692	∅113	855	∅113	E27x1

- Cast aluminum body
- PMMA
- 3000/6000K 90-260V 50/60Hz







OLO-DHL-1693

OLO-DHL-1695

OLO-DHL-1697

Item No.	A	B	C	Lamp
OLO-DHL-1693	∅113	800	∅113	LED COB 5Wx1
OLO-DHL-1694	∅113	800	∅113	E27x1
OLO-DHL-1695	∅113	828	∅113	LED COB 5Wx1
OLO-DHL-1696	∅113	828	∅113	E27x1
OLO-DHL-1697	∅113	855	∅113	LED COB 5Wx1
OLO-DHL-1698	∅113	855	∅113	E27x1

- Cast aluminum body
- PMMA
- 3000/6000K 90-260V 50/60Hz







OLO-DHL-1699

OLO-DHL-1701

OLO-DHL-1703

Item No.	A	B	C	Lamp
OLO-DHL-1699	∅140	800	∅140	LED COB 5Wx1
OLO-DHL-1700	∅140	800	∅140	E27x1
OLO-DHL-1701	∅140	830	∅140	LED COB 5Wx1
OLO-DHL-1702	∅140	830	∅140	E27x1
OLO-DHL-1703	∅140	865	∅140	LED COB 5Wx1
OLO-DHL-1704	∅140	865	∅140	E27x1

- Cast aluminum body
- PMMA
- 3000/6000K 90-260V 50/60Hz







OLO-DHL-1705

OLO-DHL-1707

OLO-DHL-1709

Item No.	A	B	C	Lamp
OLO-DHL-1705	∅140	800	∅140	LED COB 5Wx1
OLO-DHL-1706	∅140	800	∅140	E27x1
OLO-DHL-1707	∅140	830	∅140	LED COB 5Wx1
OLO-DHL-1708	∅140	830	∅140	E27x1
OLO-DHL-1709	∅140	865	∅140	LED COB 5Wx1
OLO-DHL-1710	∅140	865	∅140	E27x1

- Cast aluminum body
- PMMA
- 3000/6000K 90-260V 50/60Hz







Item No.	A	B	C	Lamp
OLO-DHL-1711	∅140	800	∅140	LED COB 5Wx1
OLO-DHL-1712	∅140	800	∅140	E27x1
OLO-DHL-1713	∅140	830	∅140	LED COB 5Wx1
OLO-DHL-1714	∅140	830	∅140	E27x1
OLO-DHL-1715	∅140	865	∅140	LED COB 5Wx1
OLO-DHL-1716	∅140	865	∅140	E27x1

- Cast aluminum body
- PMMA
- 3000/6000K 90-260V 50/60Hz





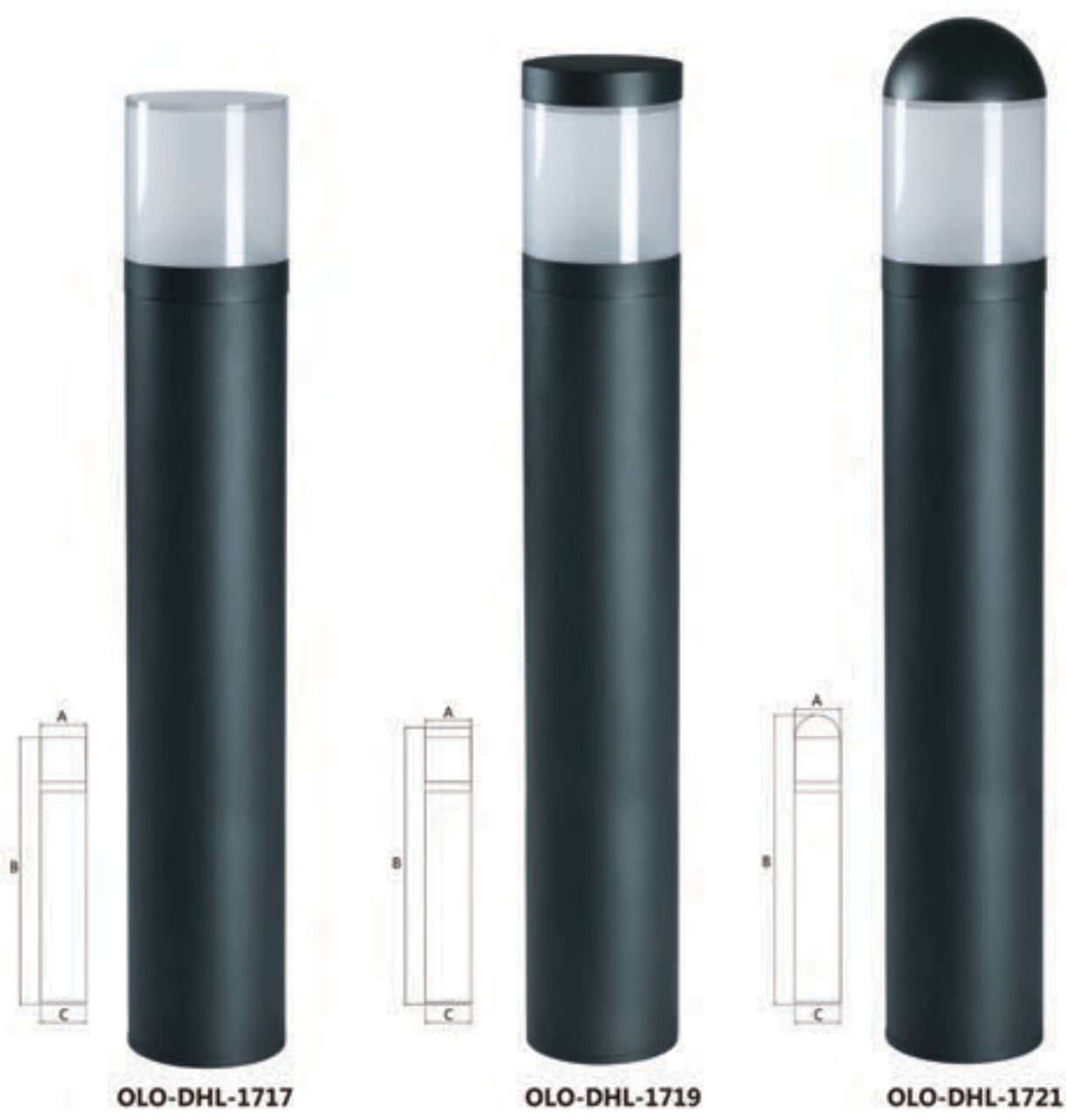

OLO-DHL-1717

OLO-DHL-1719

OLO-DHL-1721

Item No.	A	B	C	Lamp
OLO-DHL-1717	∅157	900	∅157	LED COB 5Wx1
OLO-DHL-1718	∅157	900	∅157	E27x1
OLO-DHL-1719	∅157	933	∅157	LED COB 5Wx1
OLO-DHL-1720	∅157	933	∅157	E27x1
OLO-DHL-1721	∅157	975	∅157	LED COB 5Wx1
OLO-DHL-1722	∅157	975	∅157	E27x1

- Cast aluminum body
- PMMA
- 3000/6000K 90-260V 50/60Hz







OLO-DHL-1723



OLO-DHL-1725



OLO-DHL-1727

Item No.	A	B	C	Lamp
OLO-DHL-1723	∅157	900	∅157	LED COB 5Wx1
OLO-DHL-1724	∅157	900	∅157	E27x1
OLO-DHL-1725	∅157	933	∅157	LED COB 5Wx1
OLO-DHL-1726	∅157	933	∅157	E27x1
OLO-DHL-1727	∅157	975	∅157	LED COB 5Wx1
OLO-DHL-1728	∅157	975	∅157	E27x1

- Cast aluminum body
- PMMA
- 3000/6000K 90-260V 50/60Hz



LED Lawn Light





OLO-DHL-1729

OLO-DHL-1731

OLO-DHL-1733

Item No.	A	B	C	Lamp
OLO-DHL-1729	∅157	900	∅157	LED COB 5Wx1
OLO-DHL-1730	∅157	900	∅157	E27x1
OLO-DHL-1731	∅157	933	∅157	LED COB 5Wx1
OLO-DHL-1732	∅157	933	∅157	E27x1
OLO-DHL-1733	∅157	975	∅157	LED COB 5Wx1
OLO-DHL-1734	∅157	975	∅157	E27x1

- Cast aluminum body
- PMMA
- 3000/6000K 90-260V 50/60Hz





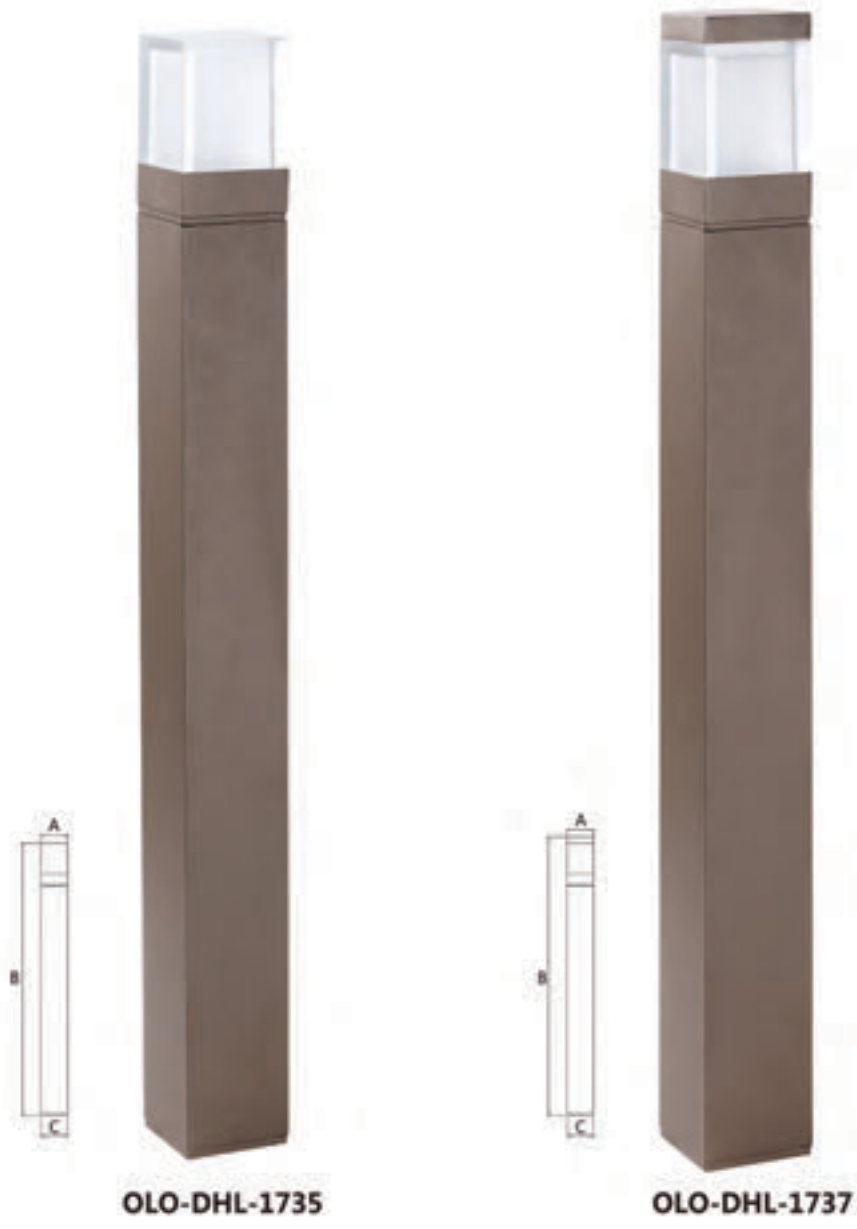

OLO-DHL-1735

OLO-DHL-1737

Item No.	A	B	C	Lamp
OLO-DHL-1735	□80	800	□80	LED COB 5Wx1
OLO-DHL-1736	□80	800	□80	E27x1
OLO-DHL-1737	□80	818	□80	LED COB 5Wx1
OLO-DHL-1738	□80	818	□80	E27x1

- Cast aluminum body
- PMMA
- 3000/6000K 90-260V 50/60Hz







OLO-DHL-1739



OLO-DHL-1741

Item No.	A	B	C	Lamp
OLO-DHL-1739	□100	800	□100	LED COB 5Wx1
OLO-DHL-1740	□100	800	□100	E27x1
OLO-DHL-1741	□100	820	□100	LED COB 5Wx1
OLO-DHL-1742	□100	820	□100	E27x1

- Cast aluminum body
- PMMA
- 3000/6000K 90-260V 50/60Hz







OLO-DHL-1743



OLO-DHL-1745

Item No.	A	B	C	Lamp
OLO-DHL-1743	□120	800	□120	LED COB 5Wx1
OLO-DHL-1744	□120	800	□120	E27x1
OLO-DHL-1745	□120	822	□120	LED COB 5Wx1
OLO-DHL-1746	□120	822	□120	E27x1

- Cast aluminum body
- PMMA
- 3000/6000K 90-260V 50/60Hz







OLO-DHL-1747



OLO-DHL-1749

Item No.	A	B	C	Lamp
OLO-DHL-1747	□150	1000	□150	LED COB SWx1
OLO-DHL-1748	□150	1000	□150	E27x1
OLO-DHL-1749	□150	1025	□150	LED COB SWx1
OLO-DHL-1750	□150	1025	□150	E27x1

- Cast aluminum body
- PMMA
- 3000/6000K 90-260V 50/60Hz







OLO-DHL-1601



OLO-DHL-1602

Item No.	A	B	C	Lamp
OLO-DHL-1601	∅280	780	∅155	LED COB 5Wx1
OLO-DHL-1640	∅280	780	∅155	LED COB 10Wx1
OLO-DHL-1641	∅280	780	∅155	E27x1
OLO-DHL-1602	∅280	780	∅155	LED COB 5Wx1
OLO-DHL-1642	∅280	780	∅155	LED COB 10Wx1
OLO-DHL-1643	∅280	780	∅155	E27x1

- Cast aluminum body
- PMMA
- 3000/6000K 90-260V 50/60Hz







OLO-DHL-1603



OLO-DHL-1604



Item No.	A	B	C	Lamp
OLO-DHL-1603	∅280	641	∅120	LED COB 5Wx1
OLO-DHL-1644	∅280	641	∅120	E27x1
OLO-DHL-1604	∅280	641	∅120	LED COB 5Wx1
OLO-DHL-1645	∅280	641	∅120	E27x1

- Cast aluminum body
- PMMA
- 3000/6000K 90-260V 50/60Hz



LED Lawn Light





OLO-DHL-1605



OLO-DHL-1606

Item No.	A	B	C	Lamp
OLO-DHL-1605	∅280	600	∅120	LED 3Wx1
OLO-DHL-1606	∅280	1200	∅120	LED COB 5Wx1

- Cast aluminum body
- PMMA
- 3000/6000K 90-260V 50/60Hz







OLO-DHL-1607

Single side



OLO-DHL-1608

Double sides

Item No.	A	B	C	D	Lamp
OLO-DHL-1607	180	955	133	190	LED COB 5Wx1
OLO-DHL-1608	180	955	133	190	LED COB 5Wx2

- Cast aluminum body
- Clear glass
- 3000/6000K 90-260V 50/60Hz







OLO-DHL-1609



OLO-DHL-1611



OLO-DHL-1613

Item No.	A	B	C	Lamp
OLO-DHL-1609	∅205	955	∅155	LED COB 10Wx1
OLO-DHL-1610	∅205	955	∅155	E27x1
OLO-DHL-1611	∅205	1000	∅155	LED COB 10Wx1
OLO-DHL-1612	∅205	1000	∅155	E27x1
OLO-DHL-1613	∅205	1000	∅155	LED COB 10Wx1
OLO-DHL-1614	∅205	1000	∅155	E27x1

- Cast aluminum body
- Clear/Frosted polycarbonate
- 3000/6000K 90-260V 50/60Hz







OLO-DHL-1615



OLO-DHL-1617



OLO-DHL-1619

Item No.	A	B	C	Lamp
OLO-DHL-1615	∅205	800	∅140	LED COB 10Wx1
OLO-DHL-1616	∅205	800	∅140	E27x1
OLO-DHL-1617	∅205	800	∅140	LED COB 10Wx1
OLO-DHL-1618	∅205	800	∅140	E27x1
OLO-DHL-1619	∅205	800	∅140	LED COB 10Wx1
OLO-DHL-1620	∅205	800	∅140	E27x1

- Cast aluminum body
- Clear/Frosted polycarbonate
- 3000/6000K 90-260V 50/60Hz







OLO-DHL-1621



OLO-DHL-1623

Item No.	A	B	C	Lamp
OLO-DHL-1621	∅205	500	∅280	LED COB 10Wx1
OLO-DHL-1622	∅205	500	∅280	E27x1
OLO-DHL-1623	∅205	500	∅280	LED COB 10Wx1
OLO-DHL-1624	∅205	500	∅280	E27x1

- Cast aluminum body
- Clear/Frosted polycarbonate
- 3000/6000K 90-260V 50/60Hz







OLO-DHL-1625



OLO-DHL-1626

Item No.	A	B	C	Lamp
OLO-DHL-1625	∅160	1015	∅210	LED COB 10Wx1
OLO-DHL-1626	∅140	1000	∅191.6	LED COB 10Wx1

- Cast aluminum body
- Clear glass
- 3000/6000K 90-260V 50/60Hz





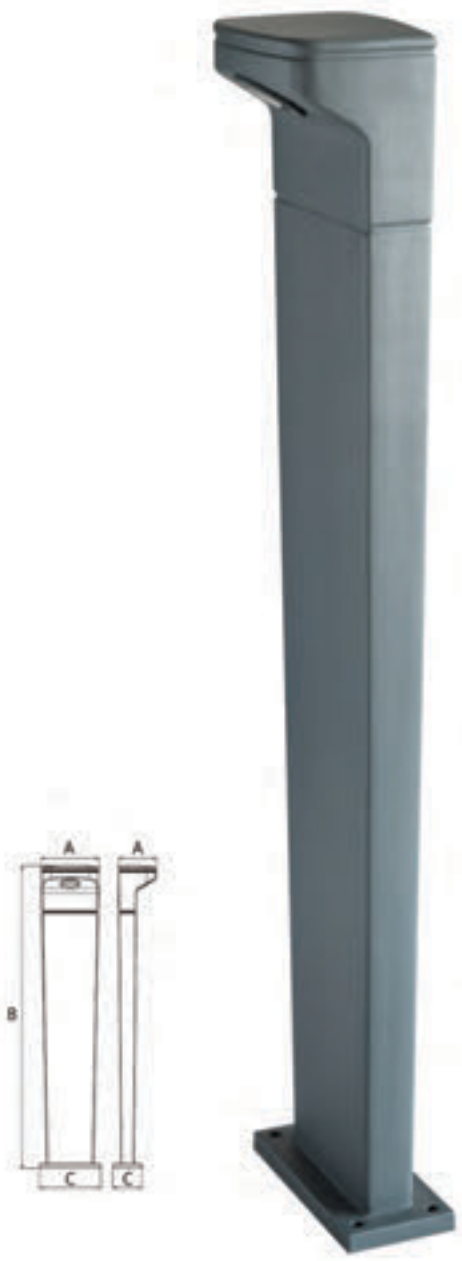

OLO-DHL-1627



OLO-DHL-1628

Item No.	A	B	C	Lamp
OLO-DHL-1627	200x131	1000	210x100	LED COB 10Wx1
OLO-DHL-1628	200x200	1000	210x100	LED COB 10Wx2

- Cast aluminum body
- Clear glass
- 3000/6000K 90-260V 50/60Hz





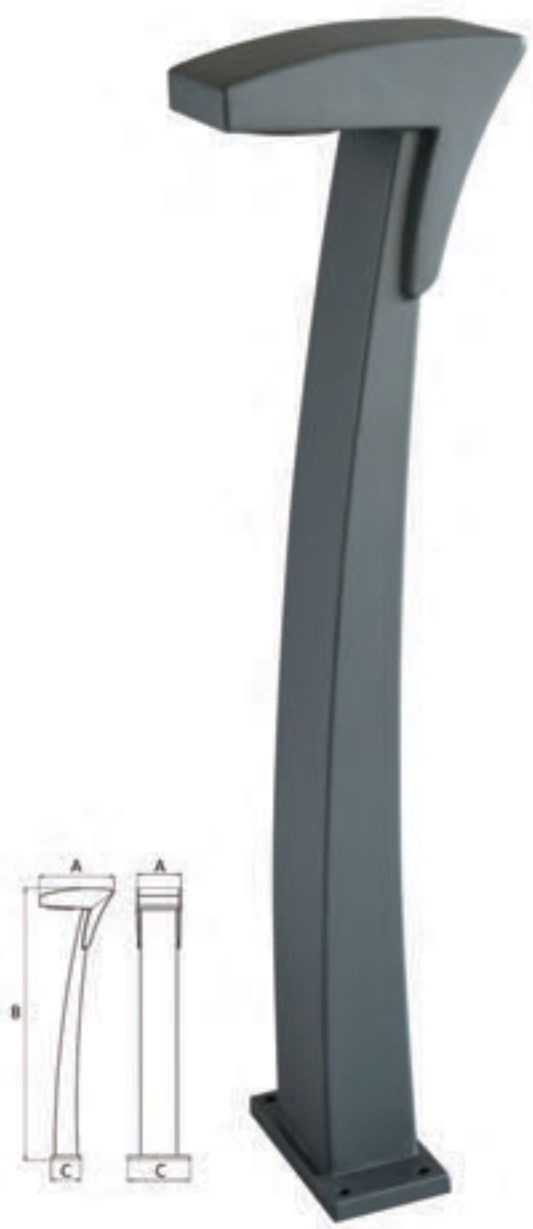

OLO-DHL-1629



OLO-DHL-1630

Item No.	A	B	C	Lamp
OLO-DHL-1629	250x150	900	210x100	LED COB 10Wx1
OLO-DHL-1630	220x150	800	210x100	LED COB 10Wx1

- Cast aluminum body
- Clear glass
- 3000/6000K 90-260V 50/60Hz







OLO-DHL-1631

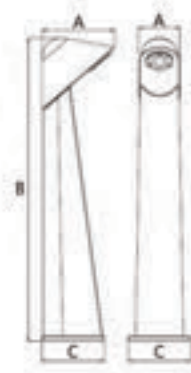

OLO-DHL-1632

Item No.	A	B	C	Lamp
OLO-DHL-1631	300	800	210x210	LED COB 10Wx1
OLO-DHL-1632	243x136	1000	210x210	LED COB 10Wx1

- Cast aluminum body
- Clear glass
- 3000/6000K 90-260V 50/60Hz







OLO-DHL-1633

Item No.	A	B	C	Lamp
OLO-DHL-1633	190x90	800	210x210	LED COB 10Wx1

- Cast aluminum body
- Clear glass
- 3000/6000K 90-260V 50/60Hz







OLO-DHL-1634



OLO-DHL-1635

Item No.	A	B	C	Lamp
OLO-DHL-1634	∅280	613	∅191.6	LED COB 5Wx1
OLO-DHL-1635	∅260	600	∅191.6	LED COB 5Wx1

- Cast aluminum body
- PMMA
- 3000/6000K 90-260V 50/60Hz





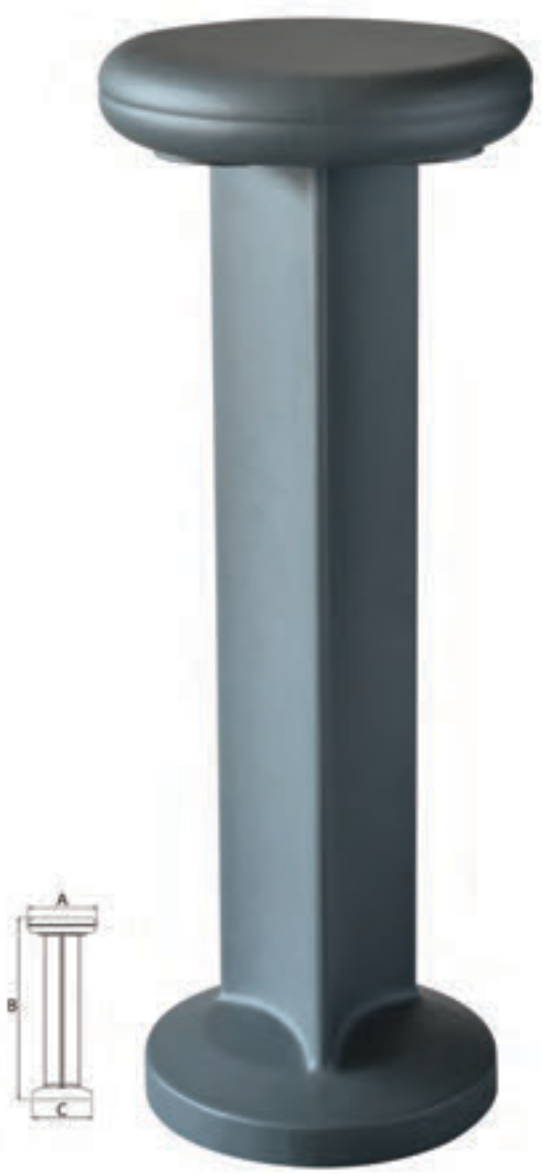

OLO-DHL-1636



OLO-DHL-1638

Item No.	A	B	C	Lamp
OLO-DHL-1636	∅230	600	∅200	LED COB 5Wx3
OLO-DHL-1637	∅230	600	∅200	LED 3Wx3
OLO-DHL-1638	∅170	503	∅129	LED COB 5Wx1
OLO-DHL-1639	∅170	503	∅129	E27x1

- Cast aluminum body
- Glass/PMMA
- 3000/6000K 90-260V 50/60Hz







OLO-DHL-1417



OLO-DHL-1418



OLO-DHL-1419

Item No.	A	B	C	Lamp
OLO-DHL-1417	□50	273	∅110	LED 3Wx1
OLO-DHL-1418	□50	400	115x85	LED 3Wx1
OLO-DHL-1419	□50	600	115x85	LED 3Wx1

- Cast aluminum body
- PMMA
- 3000/6000K 90-260V 50/60Hz





LED Lawn Light



OLO-DHL-1420



OLO-DHL-1421

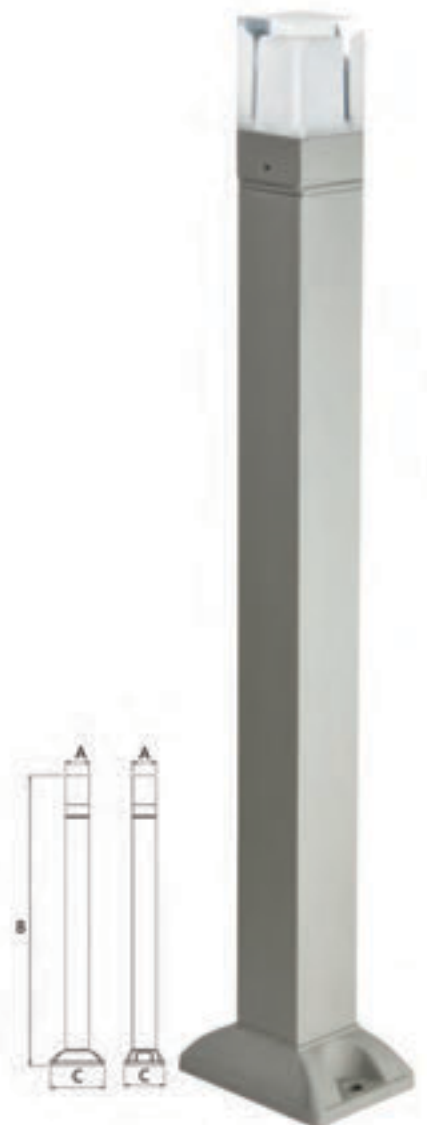

OLO-DHL-1422

Item No.	A	B	C	Lamp
OLO-DHL-1420	□50	180	∅110	LED 3Wx1
OLO-DHL-1421	□50	400	115x85	LED 3Wx1
OLO-DHL-1422	□50	600	115x85	LED 3Wx1

- Cast aluminum body
- PMMA
- 3000/6000K 90-260V 50/60Hz





Item No.	A	B	C	Lamp
OLO-DHL-1423	∅60	400	∅120	LED 3Wx1



OLO-DHL-1424



OLO-DHL-1425



OLO-DHL-1428

Item No.	A	B	C	Lamp
OLO-DHL-1424	∅60	193	∅110	LED 3Wx1
OLO-DHL-1425	∅60	400	∅120	LED 3Wx1
OLO-DHL-1426	∅60	178	∅110	LED 3Wx1
OLO-DHL-1427	∅60	400	∅120	LED 3Wx1
OLO-DHL-1428	∅60	600	∅120	LED 3Wx1
OLO-DHL-1429	∅60	800	∅120	LED 3Wx1

- Cast aluminum body
- PMMA
- 3000/6000K 90-260V 50/60Hz





Item No.	A	B	C	Lamp
OLO-DHL-1430	∅60	800	∅120	LED 3Wx1



OLO-DHL-1430



- Cast aluminum body
- PMMA
- 3000/6000K 90-260V 50/60Hz



LED Lawn Light



OLO-DHL-1432



OLO-DHL-1436



OLO-DHL-1439

Item No.	A	B	C	Lamp
OLO-DHL-1431	∅60	253	∅110	LED 3Wx1
OLO-DHL-1432	∅60	400	∅120	LED 3Wx1
OLO-DHL-1433	∅60	600	∅120	LED 3Wx1

Item No.	A	B	C	Lamp
OLO-DHL-1434	∅60	272	∅110	LED 3Wx1
OLO-DHL-1435	∅60	400	∅120	LED 3Wx1
OLO-DHL-1436	∅60	600	∅120	LED 3Wx1

Item No.	A	B	C	Lamp
OLO-DHL-1437	∅60	238	∅110	LED 3Wx1
OLO-DHL-1438	∅60	400	∅120	LED 3Wx1
OLO-DHL-1439	∅60	800	∅120	LED 3Wx1



Item No.	A	B	C	Lamp
OLO-DHL-1440	∅92	200	∅140	LED COB 5Wx1
OLO-DHL-1646	∅92	200	∅140	E27x1
OLO-DHL-1441	∅92	400	∅92	LED COB 5Wx1
OLO-DHL-1647	∅92	400	∅92	E27x1
OLO-DHL-1442	∅92	600	∅92	LED COB 5Wx1
OLO-DHL-1648	∅92	600	∅92	E27x1
OLO-DHL-1443	∅92	800	∅92	LED COB 5Wx1
OLO-DHL-1649	∅92	800	∅92	E27x1



OLO-DHL-1442



- Cast aluminum body
- PMMA
- 3000/6000K 90-260V 50/60Hz



OLO-DHL-1445



OLO-DHL-1449



OLO-DHL-1451

LED Lawn Light

Item No.	A	B	C	Lamp
OLO-DHL-1444	ø92	211	ø140	LED COB 5Wx1
OLO-DHL-1650	ø92	211	ø140	E27x1
OLO-DHL-1445	ø92	400	ø92	LED COB 5Wx1
OLO-DHL-1651	ø92	400	ø92	E27x1
OLO-DHL-1446	ø92	800	ø92	LED COB 5Wx1
OLO-DHL-1652	ø92	800	ø92	E27x1

Item No.	A	B	C	Lamp
OLO-DHL-1447	ø92	236	ø140	LED COB 5Wx1
OLO-DHL-1653	ø92	236	ø140	E27x1
OLO-DHL-1448	ø92	400	ø92	LED COB 5Wx1
OLO-DHL-1654	ø92	400	ø92	E27x1
OLO-DHL-1449	ø92	800	ø92	LED COB 5Wx1
OLO-DHL-1655	ø92	800	ø92	E27x1

Item No.	A	B	C	Lamp
OLO-DHL-1450	ø130	400	ø92	LED COB 5Wx1
OLO-DHL-1656	ø130	400	ø92	E27x1
OLO-DHL-1451	ø130	800	ø92	LED COB 5Wx1
OLO-DHL-1657	ø130	800	ø92	E27x1

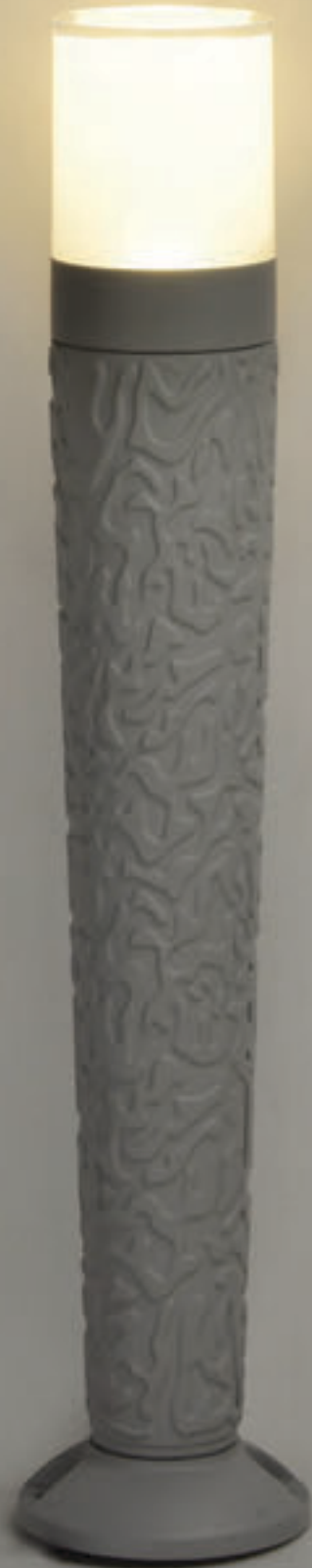



OLO-DHL-1452



OLO-DHL-1453



OLO-DHL-1454

Item No.	A	B	C	Lamp
OLO-DHL-1452	∅92	605	∅120	LED COB 5Wx1
OLO-DHL-1658	∅92	605	∅120	E27x1
OLO-DHL-1453	∅92	619	∅120	LED COB 5Wx1
OLO-DHL-1659	∅92	619	∅120	E27x1
OLO-DHL-1454	∅92	644	∅120	LED COB 5Wx1
OLO-DHL-1660	∅92	644	∅120	E27x1

- Cast aluminum body
- PMMA
- 3000/6000K 90-260V 50/60Hz







OLO-DHL-1455



OLO-DHL-1456



OLO-DHL-1457

Item No.	A	B	C	Lamp
OLO-DHL-1455	∅92	605	∅120	LED COB SWx1
OLO-DHL-1661	∅92	605	∅120	E27x1
OLO-DHL-1456	∅92	619	∅120	LED COB SWx1
OLO-DHL-1662	∅92	619	∅120	E27x1
OLO-DHL-1457	∅92	644	∅120	LED COB SWx1
OLO-DHL-1663	∅92	644	∅120	E27x1

- Cast aluminium body
- PMMA
- 3000/6000K 90-260V 50/60Hz







OLO-DHL-1458



OLO-DHL-1459



OLO-DHL-1460

Item No.	A	B	C	Lamp
OLO-DHL-1458	∅92	600	∅92	LED 3Wx2
OLO-DHL-1459	∅92	800	∅92	LED 3Wx2
OLO-DHL-1460	∅92	800	∅92	LED 3Wx1+1Wx2

- Cast aluminum body
- PMMA
- 3000/6000K 90-260V 50/60Hz







OLO-DHL-1461

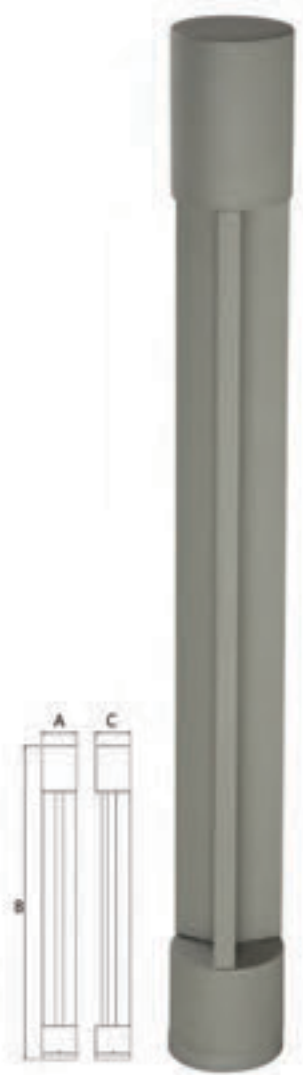

OLO-DHL-1462



OLO-DHL-1463

LED Lawn Light

Item No.	A	B	C	Lamp
OLO-DHL-1461	∅92	600	∅92	LED 1Wx3
OLO-DHL-1462	∅92	800	∅92	LED 1Wx3
OLO-DHL-1463	∅92	800	∅92	LED 3Wx1+1Wx3

- Cast aluminum body
- PMMA
- 3000/6000K 90-260V 50/60Hz







Item No.	A	B	C	Lamp
OLO-DHL-1464	∅92	600	∅92	LED COB 5Wx1
OLO-DHL-1465	∅92	800	∅92	LED COB 5Wx1
OLO-DHL-1466	∅92	800	∅92	LED 3Wx2
OLO-DHL-1467	∅92	800	∅100	LED 3Wx1

- Cast aluminum body
- PMMA
- 3000/6000K 90-260V 50/60Hz







OLO-DHL-1468

OLO-DHL-1469

OLO-DHL-1470

Item No.	A	B	C	Lamp
OLO-DHL-1468	∅92	800	286	LED 3Wx2
OLO-DHL-1469	∅92	800	189	LED 3Wx1
OLO-DHL-1470	∅92	600	∅92	LED 1Wx3

- Cast aluminum body
- Glass/PMMA
- 3000/6000K 90-260V 50/60Hz







OLO-DHL-1471



OLO-DHL-1472

Item No.	A	B	C	Lamp
OLO-DHL-1471	∅140	600	∅120	LED COB 5Wx2
OLO-DHL-1472	∅280	1000	∅120	LED COB 5Wx2

- Cast aluminum body
- Clear glass
- 3000/6000K 90-260V 50/60Hz







OLO-DHL-1473



OLO-DHL-1474

Item No.	A	B	C	Lamp
OLO-DHL-1473	105	400	80	LED COB SWx1
OLO-DHL-1474	105	600	80	LED COB SWx1

- Cast aluminum body
- Clear glass
- 3000/6000K 90-260V 50/60Hz



LED Lawn Light





OLO-DHL-1475



OLO-DHL-1476

Item No.	A	B	C	Lamp
OLO-DHL-1475	120	600	100	LED COB SWx1
OLO-DHL-1476	120	800	100	LED COB SWx1

- Cast aluminum body
- Clear glass
- 3000/6000K 90-260V 50/60Hz



LED Lawn Light





OLO-DHL-1477



OLO-DHL-1478

Item No.	A	B	C	Lamp
OLO-DHL-1477	∅140	600	∅140	LED COB SWx2
OLO-DHL-1478	∅140	800	∅140	LED COB SWx2

- Cast aluminum body
- Clear glass
- 3000/6000K 90-260V 50/60Hz





OLO-DHL-1479

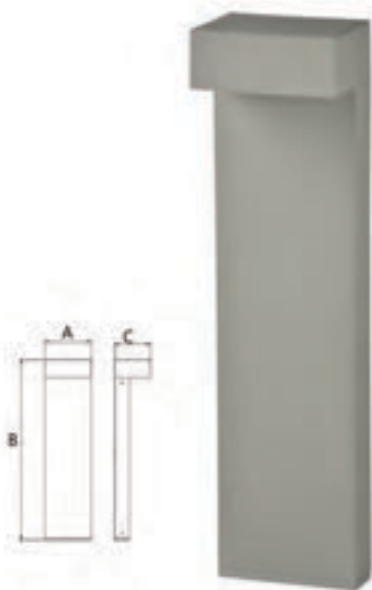

OLO-DHL-1480

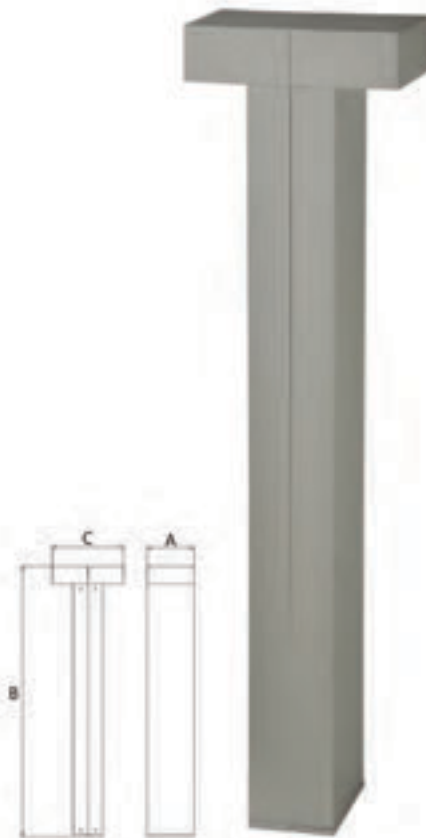

OLO-DHL-1481



OLO-DHL-1482

Item No.	A	B	C	Lamp
OLO-DHL-1479	105	600	80	LED COB 5Wx1
OLO-DHL-1480	105	400	80	LED COB 5Wx1
OLO-DHL-1481	105	600	160	LED COB 5Wx2
OLO-DHL-1482	105	600	160	LED COB 5Wx2

- Cast aluminum body
- Clear glass
- 3000/6000K 90-260V 50/60Hz







OLO-DHL-1483



OLO-DHL-1484



Item No.	A	B	C	Lamp
OLO-DHL-1483	∅342	800	∅155	LED COB 5Wx1
OLO-DHL-1484	∅342	800	∅155	LED COB 5Wx1

- Cast aluminum body
- Glass
- 3000/6000K 90-260V 50/60Hz







OLO-DHL-1485



OLO-DHL-1486

Item No.	A	B	C	Lamp
OLO-DHL-1485	∅280	700	∅155	LED COB 5Wx1
OLO-DHL-1664	∅280	700	∅155	LED COB 10Wx1
OLO-DHL-1665	∅280	700	∅155	E27x1
OLO-DHL-1486	∅280	700	∅155	LED COB 5Wx1
OLO-DHL-1666	∅280	700	∅155	LED COB 10Wx1
OLO-DHL-1667	∅280	700	∅155	E27x1

- Cast aluminum body
- PMMA
- 3000/6000K 90-260V 50/60Hz







OLO-DHL-1487



OLO-DHL-1488



OLO-DHL-1489

Item No.	A	B	C	Lamp
OLO-DHL-1487	∅92	1600	∅180	LED COB 10Wx1
OLO-DHL-1668	∅92	1600	∅180	E27x1
OLO-DHL-1488	∅92	1600	∅180	LED COB 10Wx1
OLO-DHL-1669	∅92	1600	∅180	E27x1
OLO-DHL-1489	∅92	1600	∅180	LED COB 10Wx1
OLO-DHL-1670	∅92	1600	∅180	E27x1

- Cast aluminum body
- PMMA
- 3000/6000K 90-260V 50/60Hz







Item No.	A	B	C	D	Lamp
OLO-DHL-1490	∅250	1200	∅60	∅120	LED COB 5Wx1
OLO-DHL-1491	∅300	2000	∅60	∅140	LED COB 10Wx1
OLO-DHL-1492	∅60	1600	∅60	∅140	LED COB 5Wx1

- Cast aluminum body
- PMMA
- 3000/6000K 90-260V 50/60Hz







OLO-DHL-1751



OLO-DHL-1752



OLO-DHL-1753

Item No.	A	B	C	Lamp
OLO-DHL-1751	∅113	208	145	LED COB 5Wx1
OLO-DHL-1752	∅113	236	145	LED COB 5Wx1
OLO-DHL-1753	∅113	263	145	LED COB 5Wx1



- Cast aluminum body
- PMMA
- 3000/6000K 90-260V 50/60Hz





OLO-DHL-1754



OLO-DHL-1756



OLO-DHL-1758

Item No.	A	B	C	Lamp
OLO-DHL-1754	∅140	265	203	LED COB 5Wx1
OLO-DHL-1755	∅140	265	203	E27x1
OLO-DHL-1756	∅140	295	203	LED COB 5Wx1
OLO-DHL-1757	∅140	295	203	E27x1
OLO-DHL-1758	∅140	330	203	LED COB 5Wx1
OLO-DHL-1759	∅140	330	203	E27x1



- Cast aluminum body
- PMMA
- 3000/6000K 90-260V 50/60Hz





OLO-DHL-1760



OLO-DHL-1762



OLO-DHL-1764

Item No.	A	B	C	Lamp
OLO-DHL-1760	∅157	303	220	LED COB 5Wx1
OLO-DHL-1761	∅157	303	220	E27x1
OLO-DHL-1762	∅157	336	220	LED COB 5Wx1
OLO-DHL-1763	∅157	336	220	E27x1
OLO-DHL-1764	∅157	378	220	LED COB 5Wx1
OLO-DHL-1765	∅157	378	220	E27x1



- Cast aluminum body
- PMMA
- 3000/6000K 90-260V 50/60Hz



LED Wall Light





OLO-DHL-1766

Item No.	A	B	C	Lamp
OLO-DHL-1766	□80	180	130	LED COB 5Wx1
OLO-DHL-1767	□80	198	130	LED COB 5Wx1

- Cast aluminum body
- PMMA
- 3000/6000K 90-260V 50/60Hz



OLO-DHL-1767





OLO-DHL-1768



OLO-DHL-1769

Item No.	A	B	C	Lamp
OLO-DHL-1768	□100	215	152	LED COB 5Wx1
OLO-DHL-1769	□100	235	152	LED COB 5Wx1



- Cast aluminum body
- PMMA
- 3000/6000K 90-260V 50/60Hz



LED Wall Light





OLO-DHL-1770



OLO-DHL-1772

Item No.	A	B	C	Lamp
OLO-DHL-1770	□120	260	173	LED COB 5Wx1
OLO-DHL-1771	□120	260	173	E27x1
OLO-DHL-1772	□120	282	173	LED COB 5Wx1
OLO-DHL-1773	□120	282	173	E27x1



- Cast aluminum body
- PMMA
- 3000/6000K 90-260V 50/60Hz





OLO-DHL-1774



OLO-DHL-1776

Item No.	A	B	C	Lamp
OLO-DHL-1774	□150	320	215	LED COB 5Wx1
OLO-DHL-1775	□150	320	215	E27x1
OLO-DHL-1776	□150	345	215	LED COB 5Wx1
OLO-DHL-1777	□150	345	215	E27x1

- Cast aluminum body
- PMMA
- 3000/6000K 90-260V 50/60Hz



LED Wall Light



PRODUCTS CHARACTERS:

- Body: Made of high quality die-cast aluminum with treatment of corrosion protection and UV-proof powder coating.
- Diffuser: PMMA.
- Gasketing: Made of thermostable silica gel to improve protection class.
- Fastener: Made of stainless steel with high intensity and corrosion protection.
- Application: Facade lighting, wall of buildings, villas, parks, gardens, hotels and so on.
- Finish: Matt black as standard. Matt red, Matt coffee, Matt grey, Dark grey, Dark bronze any other RAL color is available upon request.

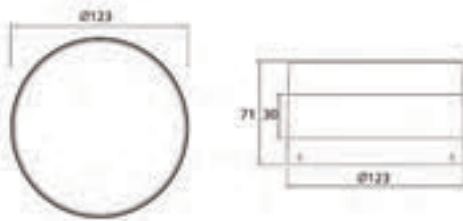

OLO-DHL-1301D(R) Single Color

● Red LED 1Wx2 90-260V 50/60Hz

OLO-DHL-1301D(G) Single Color

● Green LED 1Wx2 90-260V 50/60Hz

OLO-DHL-1301D(B) Single Color

● Blue LED 1Wx2 90-260V 50/60Hz

OLO-DHL-1301D(Y) Single Color

● Yellow LED 1Wx2 90-260V 50/60Hz

OLO-DHL-1301D(WW) Single Color

● Warm White LED 1Wx2 90-260V 50/60Hz

OLO-DHL-1301D(W) Single Color

○ White LED 1Wx2 90-260V 50/60Hz

Angle between light beams: 90° . 180°



LED Wall Light

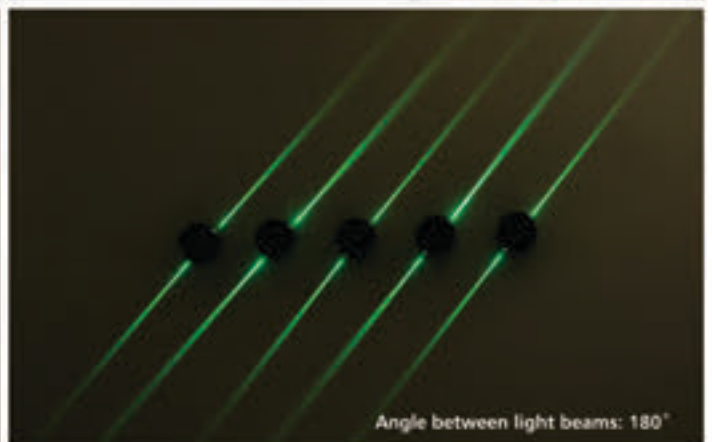
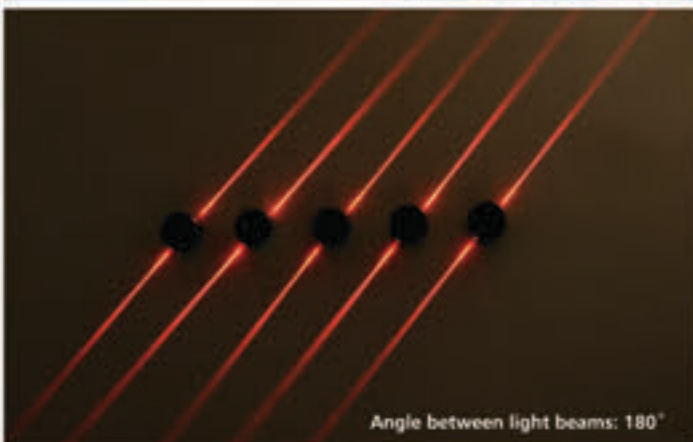
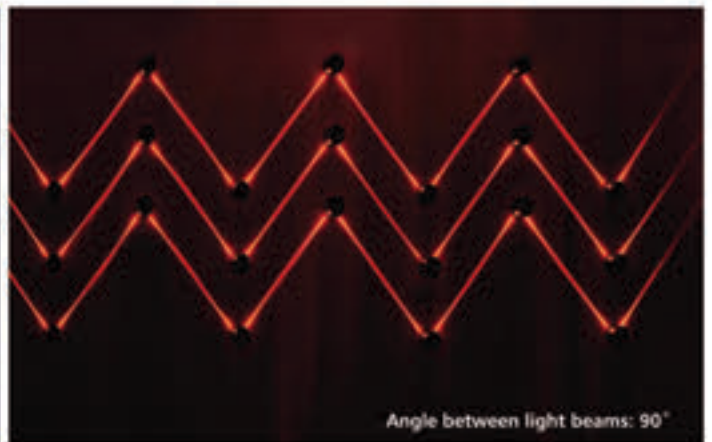
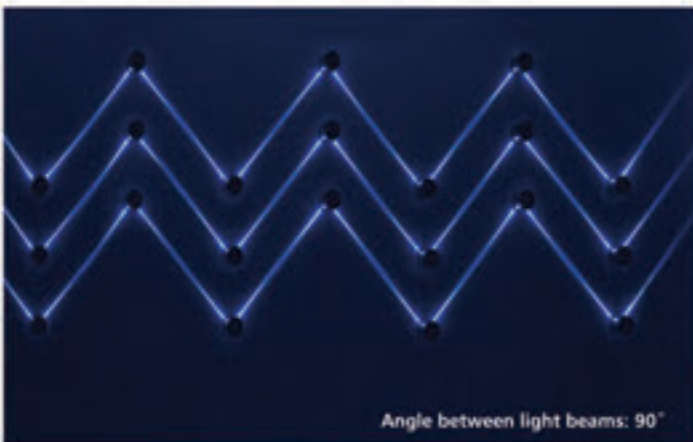



PRODUCTS CHARACTERS:

- Body: Made of high quality die-cast aluminum with treatment of corrosion protection and UV-proof powder coating.
- Diffuser: PMMA.
- Gasketing: Made of thermostable silica gel to improve protection class.
- Fastener: Made of stainless steel with high intensity and corrosion protection.
- Application: acade lighting, wall of buildings, villas, parks, gardens, hotels and so on.
- Finish: Matt black as standard. Matt red, Matt coffee, Matt grey, Dark grey, Dark bronze any other RAL color is available upon request.

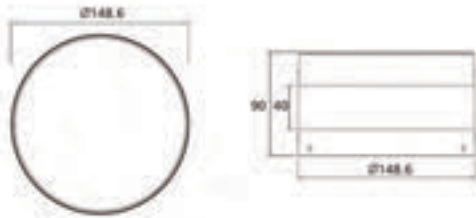

OLO-DHL-1301T				RGB(Flash)
RGB	LED	2W	175-250V	50/60Hz

OLO-DHL-1301J				RGB(Fade)
RGB	LED	2W	175-250V	50/60Hz

OLO-DHL-1301C				RGB(Pre-programmed)
RGB	LED	6W	90-260V	50/60Hz

Angle between light beams: 90° - 180°

For video about lighting effect, please visit website.
www.daheng168.com

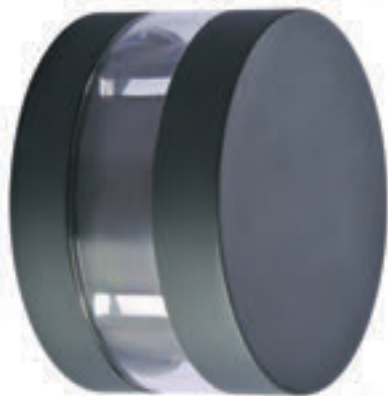

LED Wall Light

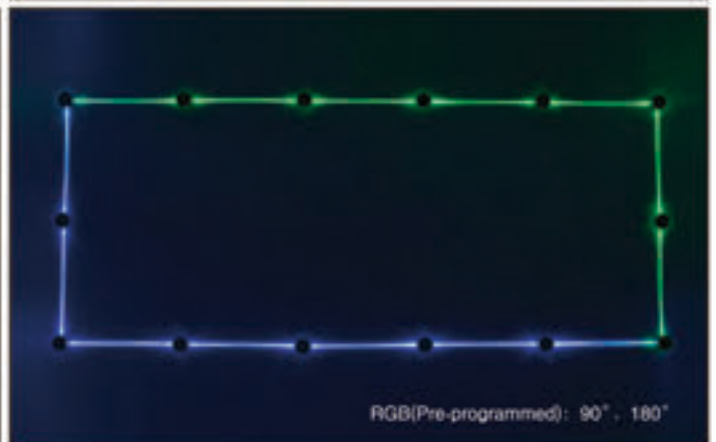
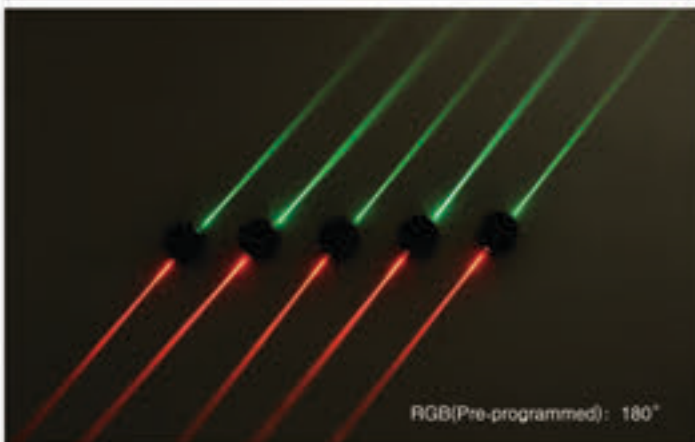
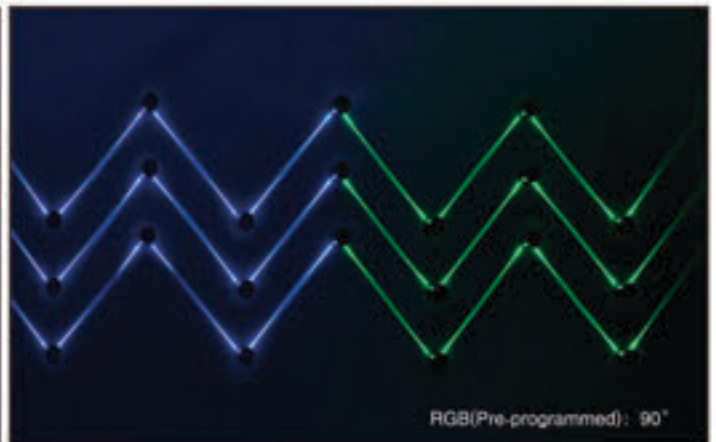



PRODUCTS CHARACTERS:

- Body: Made of high quality die-cast aluminum with treatment of corrosion protection and UV-proof powder coating.
- Diffuser: PMMA.
- Gasketing: Made of thermostable silica gel to improve protection class.
- Fastener: Made of stainless steel with high intensity and corrosion protection.
- Application: Facade lighting, wall of buildings, villas, parks, gardens, hotels and so on.
- Finish: Matt black as standard. Matt red, Matt coffee, Matt grey, Dark grey, Dark bronze any other RAL color is available upon request.

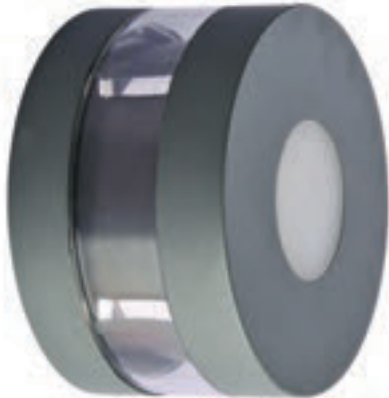
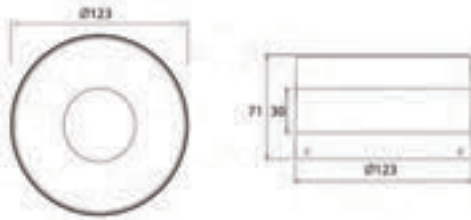

OLO-DHL-1302D(R)				Single Color
Red	LED	1Wx3	90-260V	50/60Hz

OLO-DHL-1302D(G)				Single Color
Green	LED	1Wx3	90-260V	50/60Hz

OLO-DHL-1302D(B)				Single Color
Blue	LED	1Wx3	90-260V	50/60Hz

OLO-DHL-1302D(Y)				Single Color
Yellow	LED	1Wx3	90-260V	50/60Hz

OLO-DHL-1302D(WW)				Single Color
Warm White	LED	1Wx3	90-260V	50/60Hz

OLO-DHL-1302D(W)				Single Color
White	LED	1Wx3	90-260V	50/60Hz

Angle between light beams: 90° , 180°

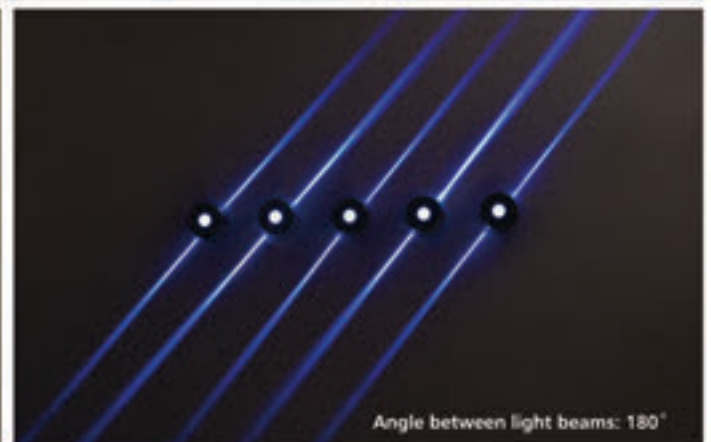
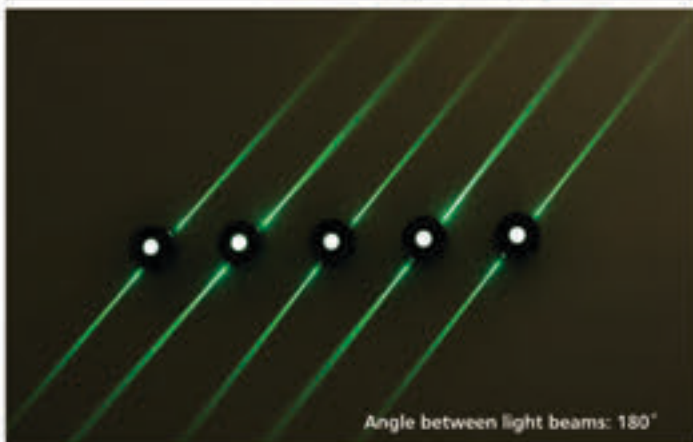
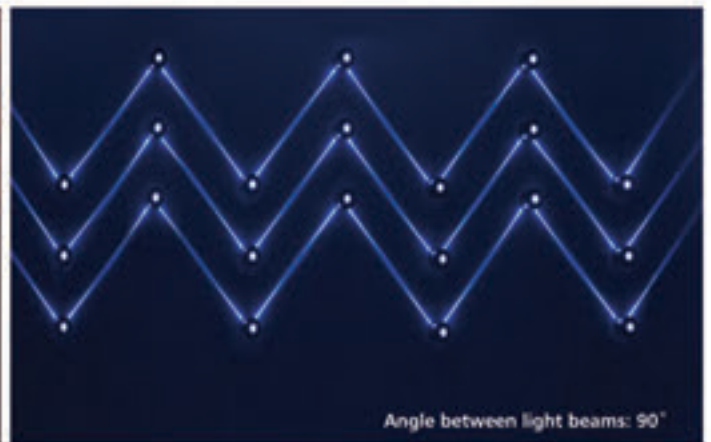
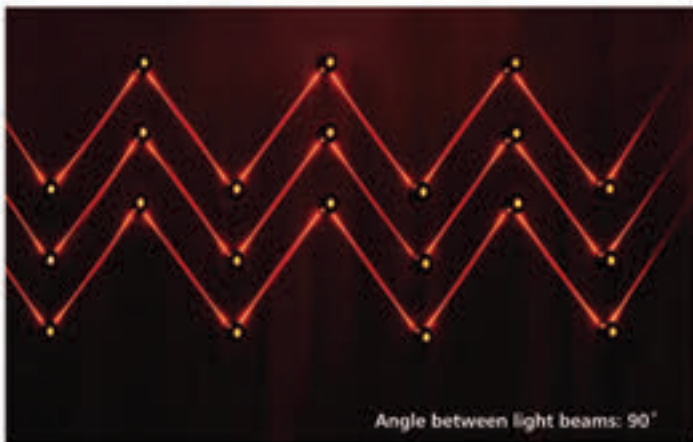



PRODUCTS CHARACTERS:

- Body: Made of high quality die-cast aluminum with treatment of corrosion protection and UV-proof powder coating.
- Diffuser: PMMA.
- Gasketing: Made of thermostable silica gel to improve protection class.
- Fastener: Made of stainless steel with high intensity and corrosion protection.
- Application: Facade lighting, wall of buildings, villas, parks, gardens, hotels and so on.
- Finish: Matt black as standard. Matt red, Matt coffee, Matt grey, Dark grey, Dark bronze any other RAL color is available upon request.

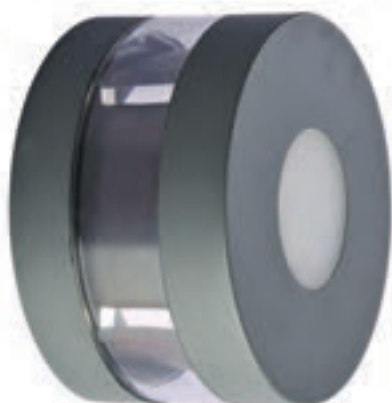
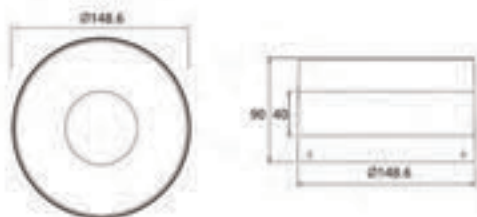

OLO-DHL-1302T					RGB(Flash)
RGB	LED	3W	175-250V	50/60Hz	

OLO-DHL-1302J					RGB(Fade)
RGB	LED	3W	175-250V	50/60Hz	

OLO-DHL-1302C					RGB(Pre-programmed)
RGB	LED	7W	90-260V	50/60Hz	

Angle between light beams: 90° , 180°

For video about lighting effect, please visit website:
www.daheng168.com

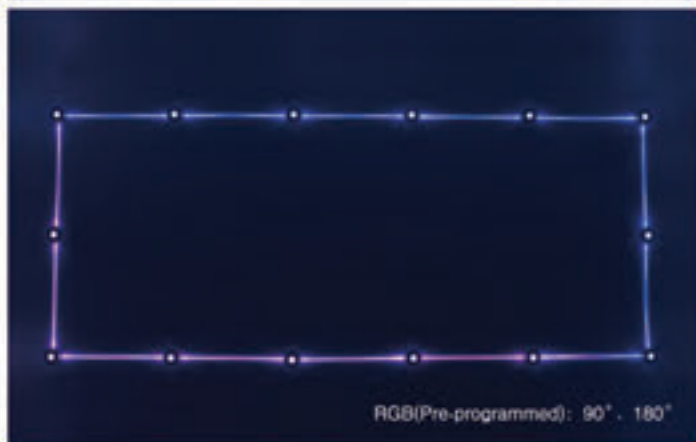
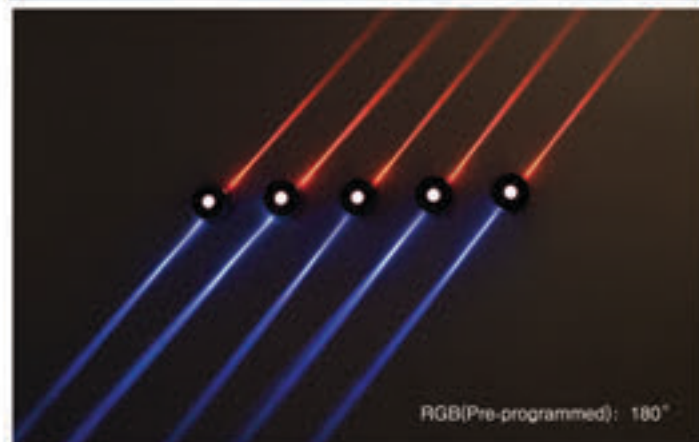



PRODUCTS CHARACTERS:

- Body: Made of high quality die-cast aluminum with treatment of corrosion protection and UV-proof powder coating.
- Diffuser: PMMA.
- Gasketing: Made of thermostable silica gel to improve protection class.
- Fastener: Made of stainless steel with high intensity and corrosion protection.
- Application: Facade lighting, wall of buildings, villas, parks, gardens, hotels and so on.
- Finish: Matt black as standard, Matt red, Matt coffee, Matt grey, Dark grey, Dark bronze any other RAL color is available upon request.

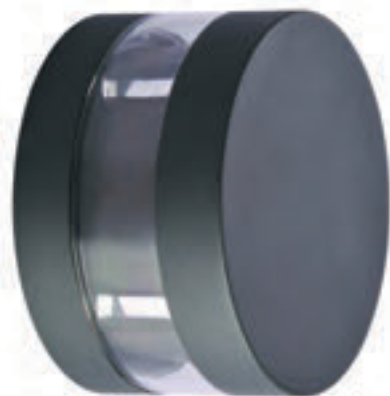
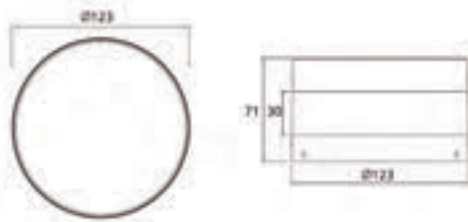

OLO-DHL-1303D(R)				Single Color
● Red	LED	1Wx3	90-260V	50/60Hz
OLO-DHL-1303D(G)				Single Color
● Green	LED	1Wx3	90-260V	50/60Hz
OLO-DHL-1303D(B)				Single Color
● Blue	LED	1Wx3	90-260V	50/60Hz
OLO-DHL-1303D(Y)				Single Color
● Yellow	LED	1Wx3	90-260V	50/60Hz
OLO-DHL-1303D(WW)				Single Color
● Warm White	LED	1Wx3	90-260V	50/60Hz
OLO-DHL-1303D(W)				Single Color
○ White	LED	1Wx3	90-260V	50/60Hz

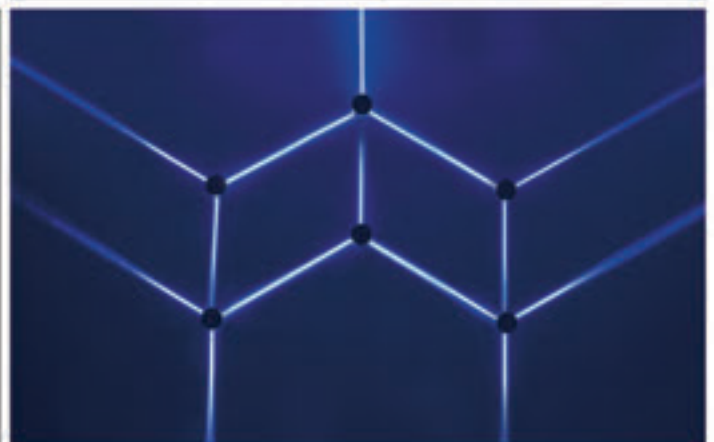
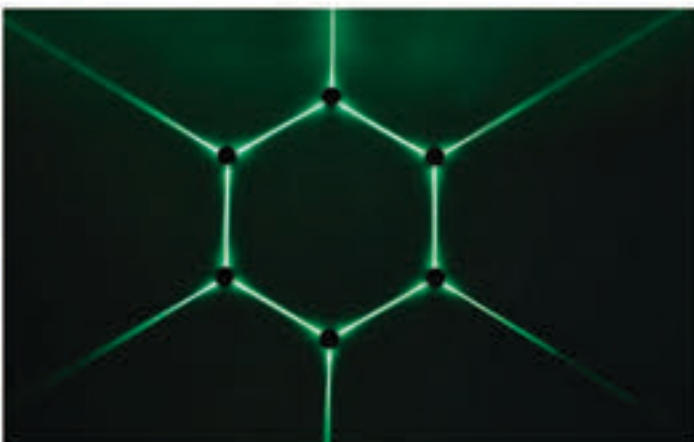



PRODUCTS CHARACTERS:

- Body: Made of high quality die-cast aluminum with treatment of corrosion protection and UV-proof powder coating.
- Diffuser: PMMA.
- Gasketing: Made of thermostable silica gel to improve protection class.
- Fastener: Made of stainless steel with high intensity and corrosion protection.
- Application: Facade lighting, wall of buildings, villas, parks, gardens, hotels and so on.
- Finish: Matt black as standard. Matt red, Matt coffee, Matt grey, Dark grey, Dark bronze any other RAL color is available upon request.

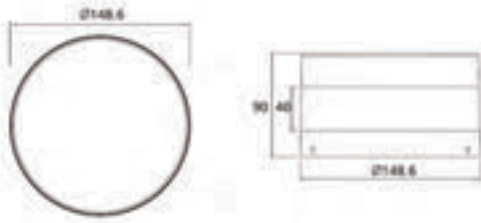

OLO-DHL-1303T				RGB(Flash)
RGB	LED	3W	175-250V	50/60Hz

OLO-DHL-1303J				RGB(Fade)
RGB	LED	3W	175-250V	50/60Hz

OLO-DHL-1303C				RGB(Pre-programmed)
RGB	LED	9W	90-260V	50/60Hz

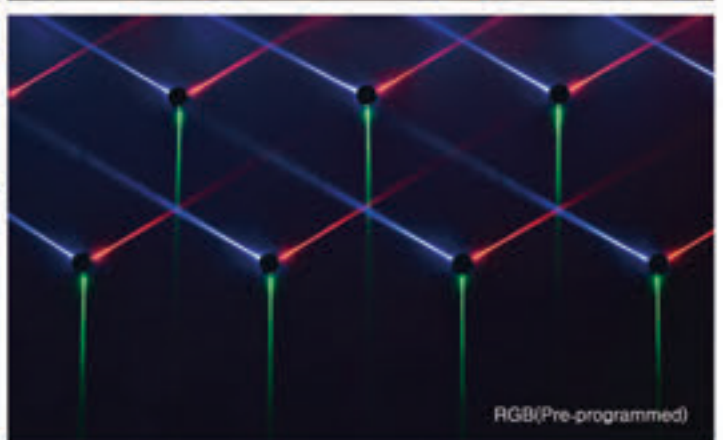
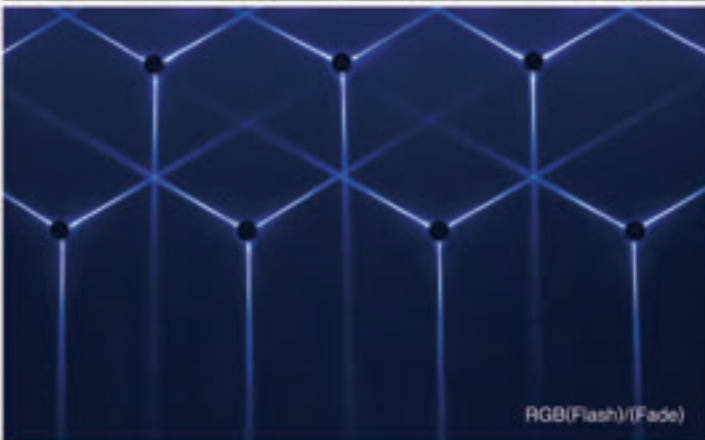
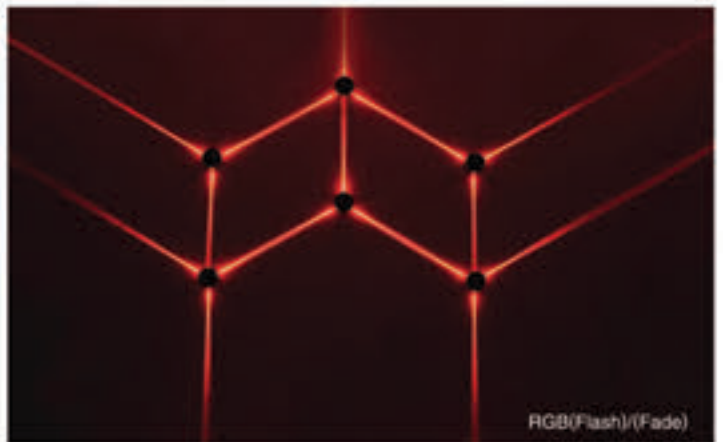
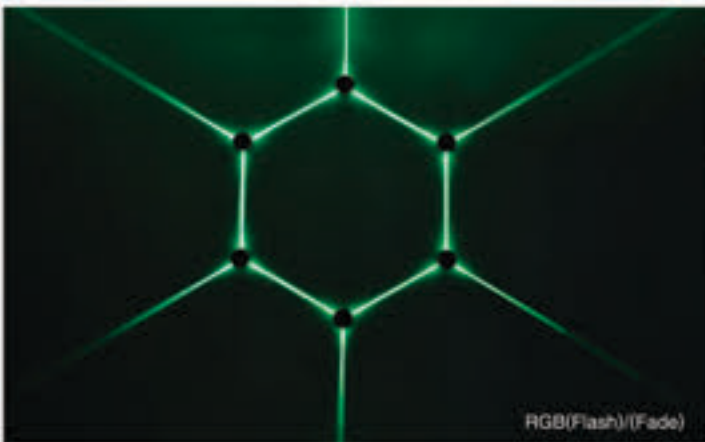
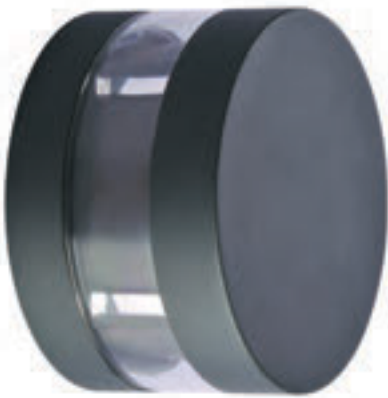



PRODUCTS CHARACTERS:

- Body: Made of high quality die-cast aluminum with treatment of corrosion protection and UV-proof powder coating.
- Diffuser: PMMA.
- Gasketing: Made of thermostable silica gel to improve protection class.
- Fastener: Made of stainless steel with high intensity and corrosion protection.
- Application: Facade lighting, wall of buildings, villas, parks, gardens, hotels and so on.
- Finish: Matt black as standard. Matt red, Matt coffee, Matt grey, Dark grey, Dark bronze any other RAL color is available upon request.

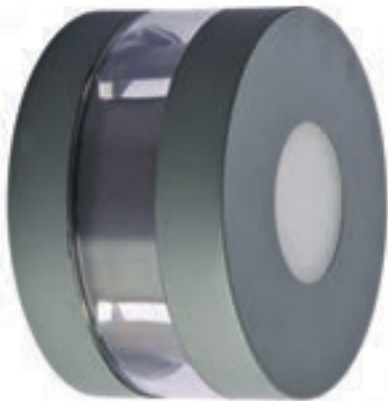
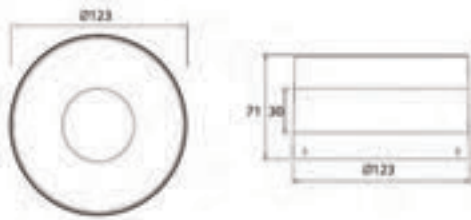

OLO-DHL-1304D(R) Single Color				
● Red	LED	1Wx4	90-260V	50/60Hz
OLO-DHL-1304D(G) Single Color				
● Green	LED	1Wx4	90-260V	50/60Hz
OLO-DHL-1304D(B) Single Color				
● Blue	LED	1Wx4	90-260V	50/60Hz
OLO-DHL-1304D(Y) Single Color				
● Yellow	LED	1Wx4	90-260V	50/60Hz
OLO-DHL-1304D(WW) Single Color				
● Warm White	LED	1Wx4	90-260V	50/60Hz
OLO-DHL-1304D(W) Single Color				
○ White	LED	1Wx4	90-260V	50/60Hz

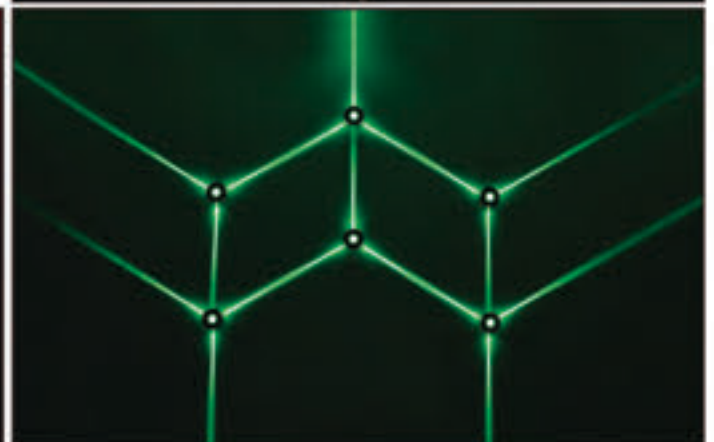
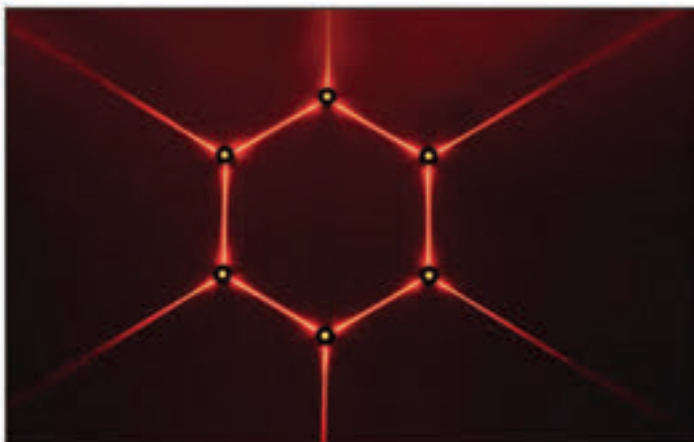



PRODUCTS CHARACTERS:

- Body: Made of high quality die-cast aluminum with treatment of corrosion protection and UV-proof powder coating.
- Diffuser: PMMA.
- Gasketing: Made of thermostable silica gel to improve protection class.
- Fastener: Made of stainless steel with high intensity and corrosion protection.
- Application: Facade lighting, wall of buildings, villas, parks, gardens, hotels and so on.
- Finish: Matt black as standard. Matt red, Matt coffee, Matt grey, Dark grey, Dark bronze any other RAL color is available upon request.

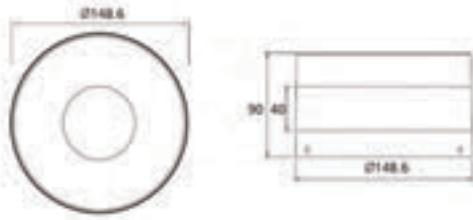

OLO-DHL-1304T					RGB(Flash)
RGB	LED	4W	175-250V	50/60Hz	

OLO-DHL-1304J					RGB(Fade)
RGB	LED	4W	175-250V	50/60Hz	

OLO-DHL-1304C					RGB(Pre-programmed)
RGB	LED	10W	90-260V	50/60Hz	

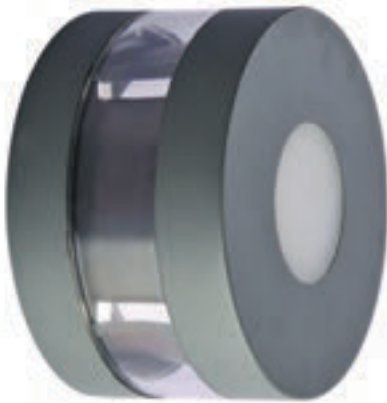

LED Wall Light

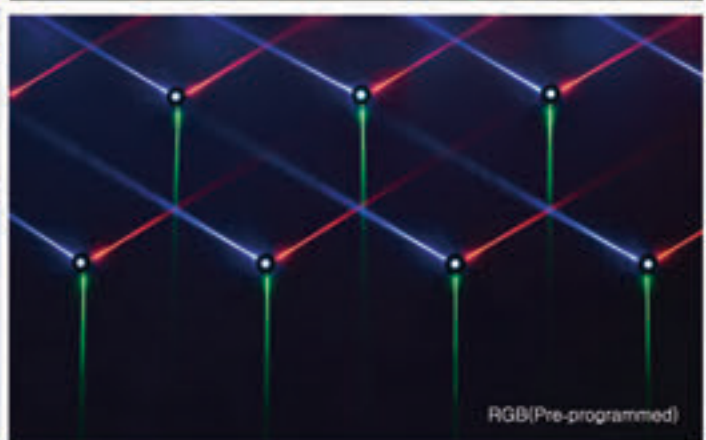
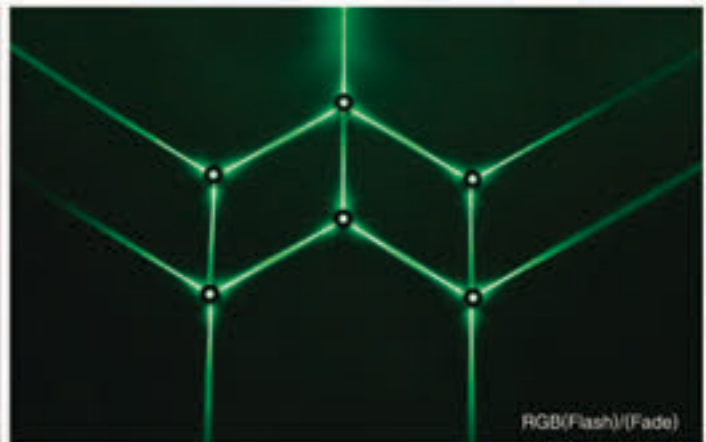
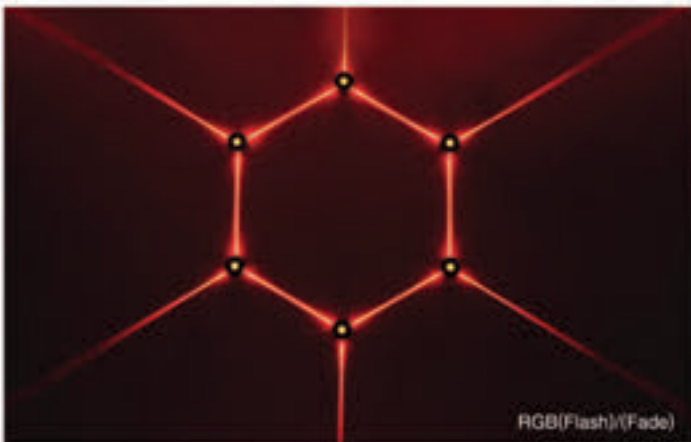



PRODUCTS CHARACTERS:

- Body: Made of high quality die-cast aluminum with treatment of corrosion protection and UV-proof powder coating.
- Diffuser: PMMA.
- Gasketing: Made of thermostable silica gel to improve protection class.
- Fastener: Made of stainless steel with high intensity and corrosion protection.
- Application: Facade lighting, wall of buildings, villas, parks, gardens, hotels and so on.
- Finish: Matt black as standard. Matt red, Matt coffee, Matt grey, Dark grey, Dark bronze any other RAL color is available upon request.

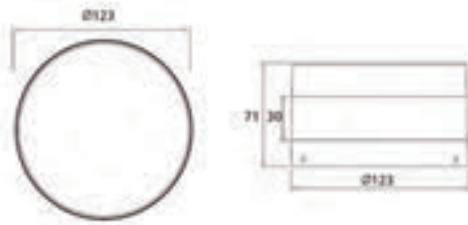

OLO-DHL-1305(R)				Single Color
● Red	LED	1Wx4	90-260V	50/60Hz

OLO-DHL-1305(G)				Single Color
● Green	LED	1Wx4	90-260V	50/60Hz

OLO-DHL-1305(B)				Single Color
● Blue	LED	1Wx4	90-260V	50/60Hz

OLO-DHL-1305(Y)				Single Color
● Yellow	LED	1Wx4	90-260V	50/60Hz

OLO-DHL-1305(WW)				Single Color
● Warm White	LED	1Wx4	90-260V	50/60Hz

OLO-DHL-1305(W)				Single Color
○ White	LED	1Wx4	90-260V	50/60Hz



LED Wall Light

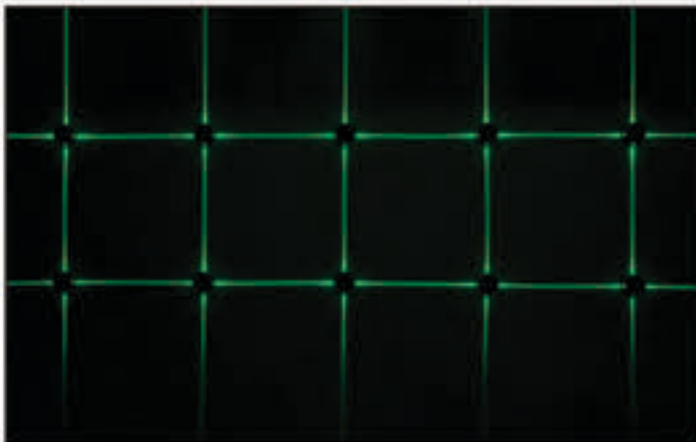



PRODUCTS CHARACTERS:

- Body: Made of high quality die-cast aluminum with treatment of corrosion protection and UV-proof powder coating.
- Diffuser: PMMA.
- Gasketing: Made of thermostable silica gel to improve protection class.
- Fastener: Made of stainless steel with high intensity and corrosion protection.
- Application: Facade lighting, wall of buildings, villas, parks, gardens, hotels and so on.
- Finish: Matt black as standard. Matt red, Matt coffee, Matt grey, Dark grey, Dark bronze any other RAL color is available upon request.

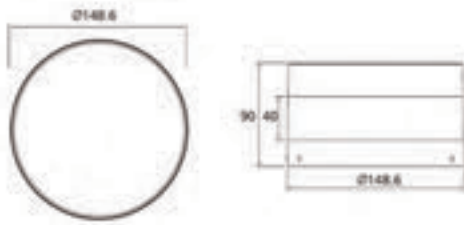

OLO-DHL-1306					RGB(Flash)
RGB	LED	4W	175-250V	50/60Hz	

OLO-DHL-1307					RGB(Fade)
RGB	LED	4W	175-250V	50/60Hz	

OLO-DHL-1308					RGB(Pre-programmed)
RGB	LED	12W	90-260V	50/60Hz	



LED Wall Light

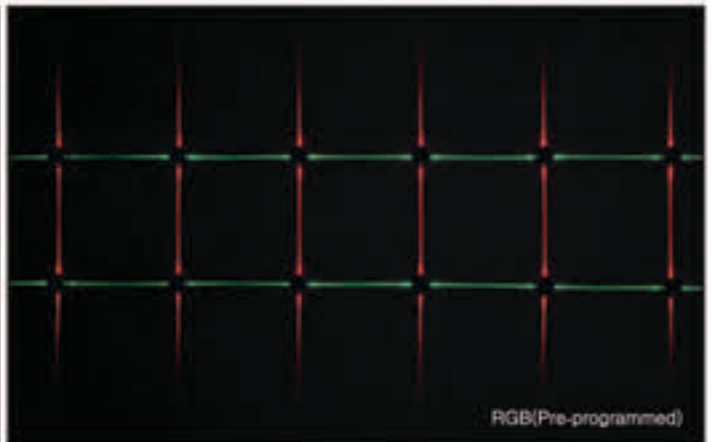
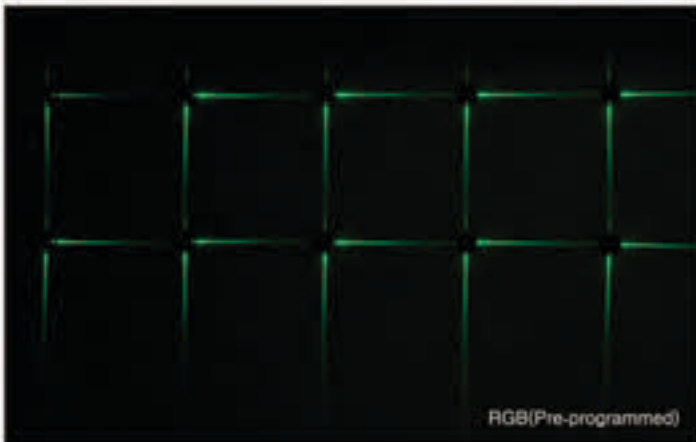
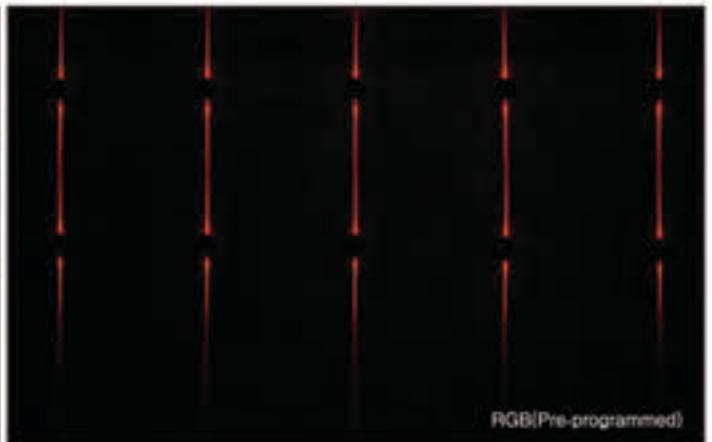
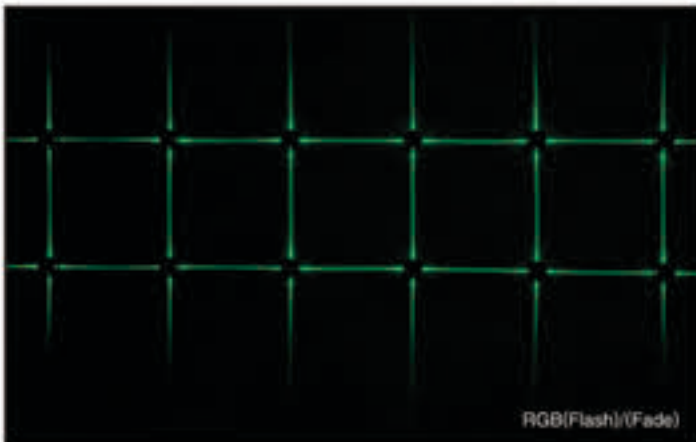



PRODUCTS CHARACTERS:

- Body: Made of high quality die-cast aluminum with treatment of corrosion protection and UV-proof powder coating.
- Diffuser: PMMA.
- Gasketing: Made of thermostable silica gel to improve protection class.
- Fastener: Made of stainless steel with high intensity and corrosion protection.
- Application: Facade lighting, wall of buildings, villas, parks, gardens, hotels and so on.
- Finish: Matt black as standard. Matt red, Matt coffee, Matt grey, Dark grey, Dark bronze any other RAL color is available upon request.

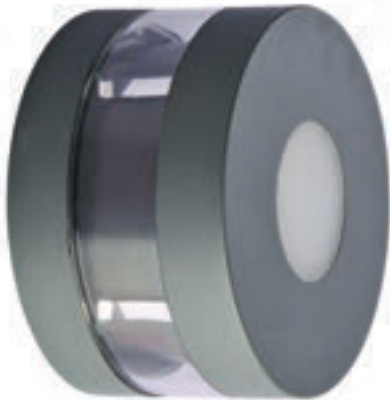
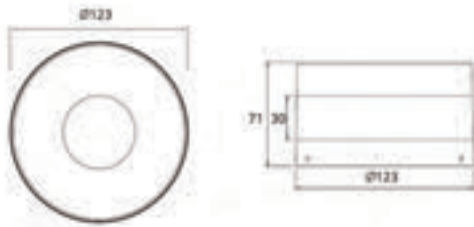

OLO-DHL-1309(R)				Single Color
● Red	LED	1Wx5	90-260V	50/60Hz

OLO-DHL-1309(G)				Single Color
● Green	LED	1Wx5	90-260V	50/60Hz

OLO-DHL-1309(B)				Single Color
● Blue	LED	1Wx5	90-260V	50/60Hz

OLO-DHL-1309(Y)				Single Color
● Yellow	LED	1Wx5	90-260V	50/60Hz

OLO-DHL-1309(WW)				Single Color
● Warm White	LED	1Wx5	90-260V	50/60Hz

OLO-DHL-1309(W)				Single Color
○ White	LED	1Wx5	90-260V	50/60Hz

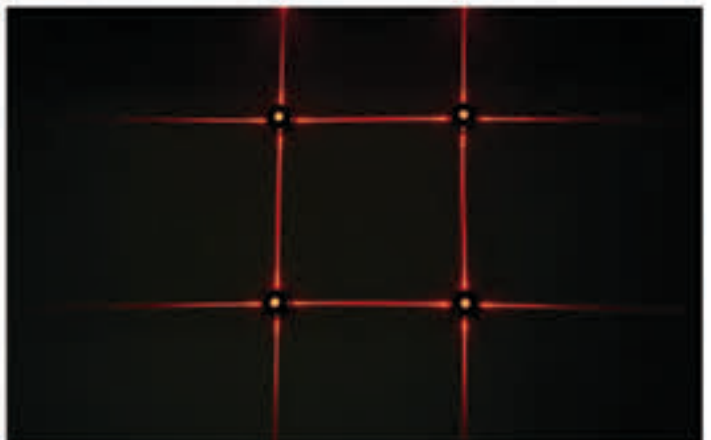



PRODUCTS CHARACTERS:

- Body: Made of high quality die-cast aluminum with treatment of corrosion protection and UV-proof powder coating.
- Diffuser: PMMA.
- Gasketing: Made of thermostable silica gel to improve protection class.
- Fastener: Made of stainless steel with high intensity and corrosion protection.
- Application: Facade lighting, wall of buildings, villas, parks, gardens, hotels and so on.
- Finish: Matt black as standard. Matt grey, Matt coffee, Matt black, Dark grey, Dark bronze any other RAL color is available upon request.

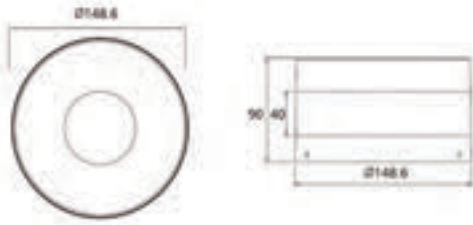

OLO-DHL-1310				RGB(Flash)
RGB	LED	5W	175-250V	50/60Hz

OLO-DHL-1311				RGB(Fade)
RGB	LED	5W	175-250V	50/60Hz

OLO-DHL-1312				RGB(Pre-programmed)
RGB	LED	13W	90-260V	50/60Hz

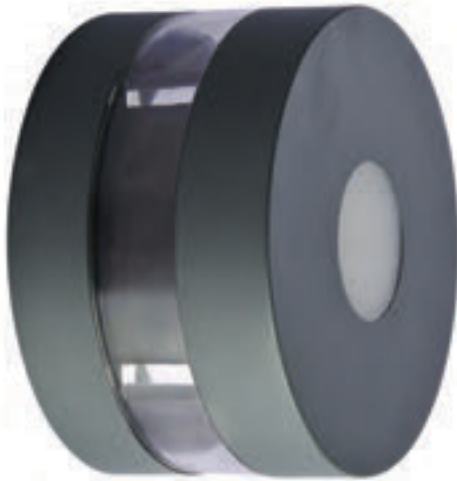

LED Wall Light

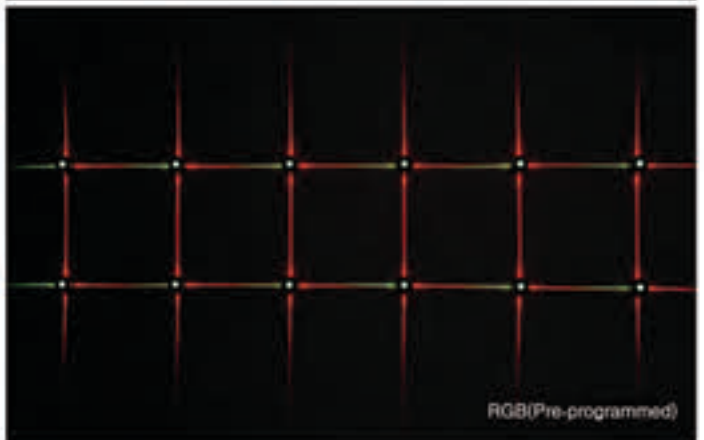
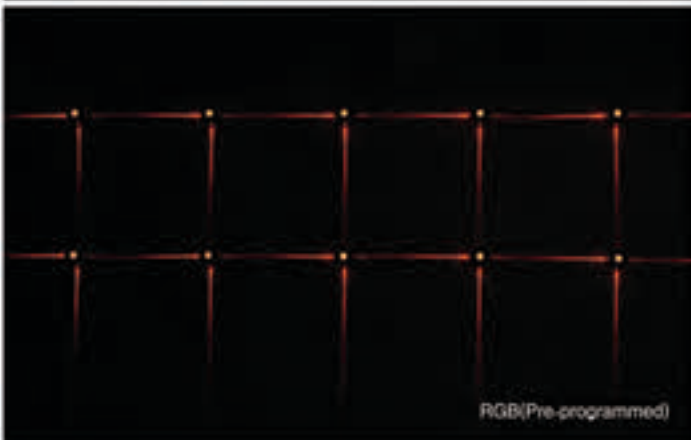
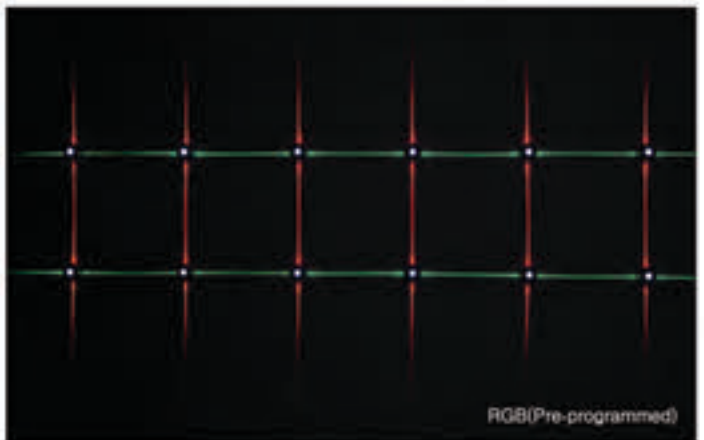
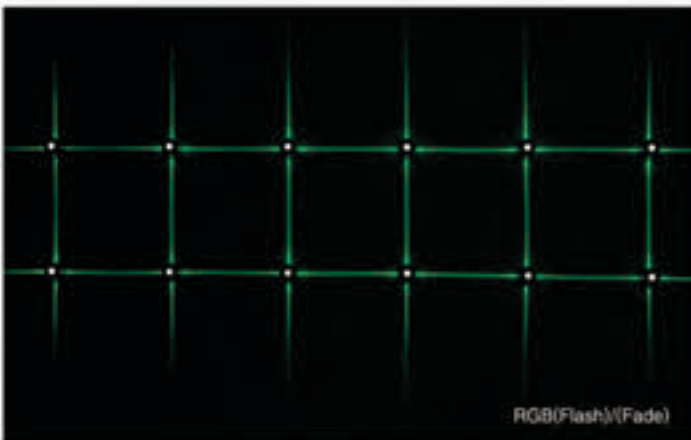



PRODUCTS CHARACTERS:

- Body: Made of high quality die-cast aluminum with treatment of corrosion protection and UV-proof powder coating.
- Diffuser: PMMA.
- Gasketing: Made of thermostable silica gel to improve protection class.
- Fastener: Made of stainless steel with high intensity and corrosion protection.
- Application: Facade lighting, wall of buildings, villas, parks, gardens, hotels and so on.
- Finish: Matt black as standard. Matt red, Matt coffee, Matt grey, Dark grey, Dark bronze any other RAL color is available upon request.

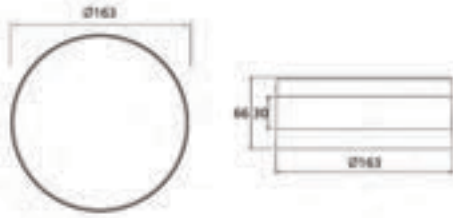

OLO-DHL-1313(R)				Single Color
● Red	LED	1Wx8	90-260V	50/60Hz

OLO-DHL-1313(G)				Single Color
● Green	LED	1Wx8	90-260V	50/60Hz

OLO-DHL-1313(B)				Single Color
● Blue	LED	1Wx8	90-260V	50/60Hz

OLO-DHL-1313(Y)				Single Color
● Yellow	LED	1Wx8	90-260V	50/60Hz

OLO-DHL-1313(WW)				Single Color
● Warm White	LED	1Wx8	90-260V	50/60Hz

OLO-DHL-1313(W)				Single Color
○ White	LED	1Wx8	90-260V	50/60Hz

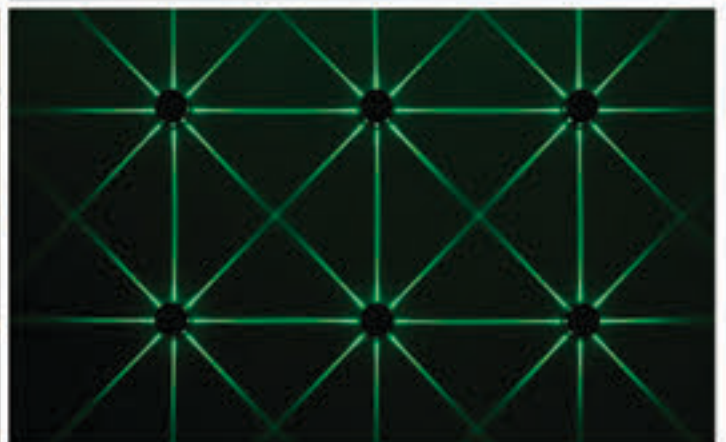
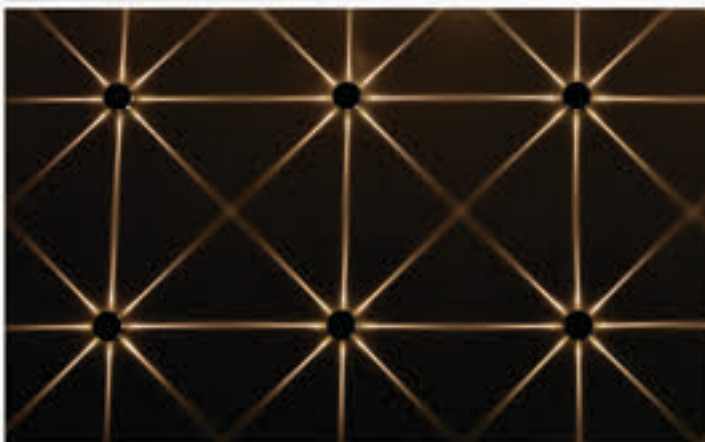
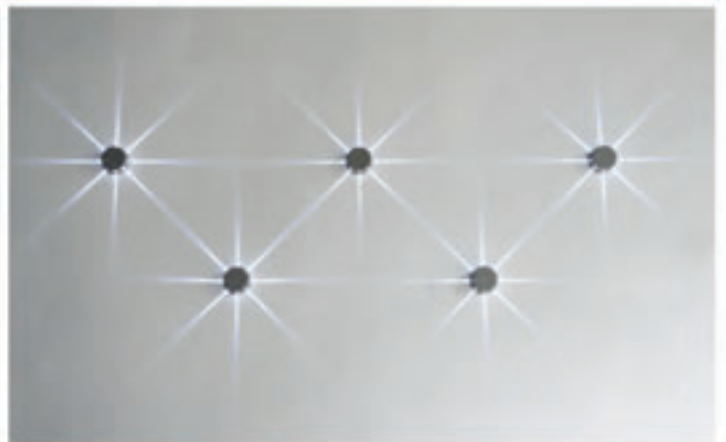



PRODUCTS CHARACTERS:

- Body: Made of high quality die-cast aluminum with treatment of corrosion protection and UV-proof powder coating.
- Diffuser: PMMA.
- Gasketing: Made of thermostable silica gel to improve protection class.
- Fastener: Made of stainless steel with high intensity and corrosion protection.
- Application: Facade lighting, wall of buildings, villas, parks, gardens, hotels and so on.
- Finish: Matt black as standard. Matt red, Matt coffee, Matt grey, Dark grey, Dark bronze any other RAL color is available upon request.

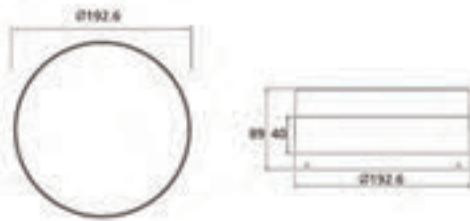

OLO-DHL-1314				RGB(Flash)
RGB	LED	8W	175-250V	50/60Hz

OLO-DHL-1315				RGB(Fade)
RGB	LED	8W	175-250V	50/60Hz

OLO-DHL-1316				RGB(Pre-programmed)
RGB	LED	24W	90-260V	50/60Hz

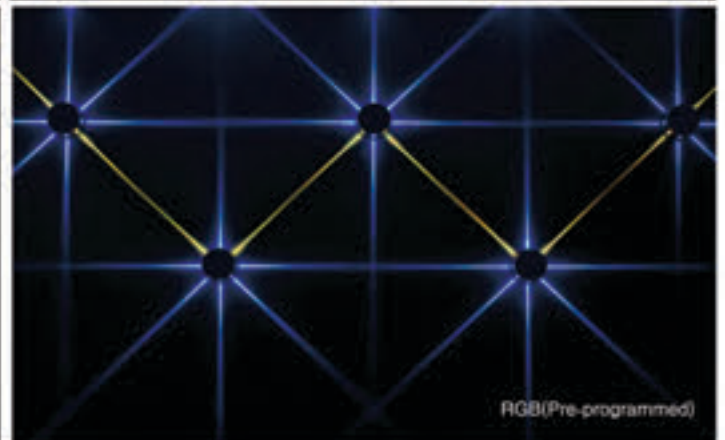
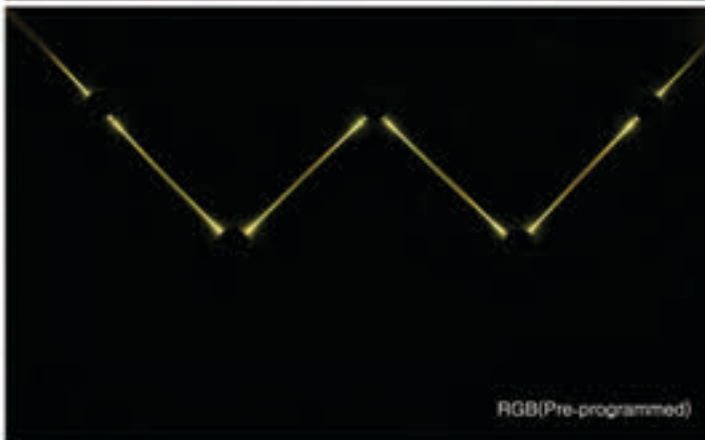
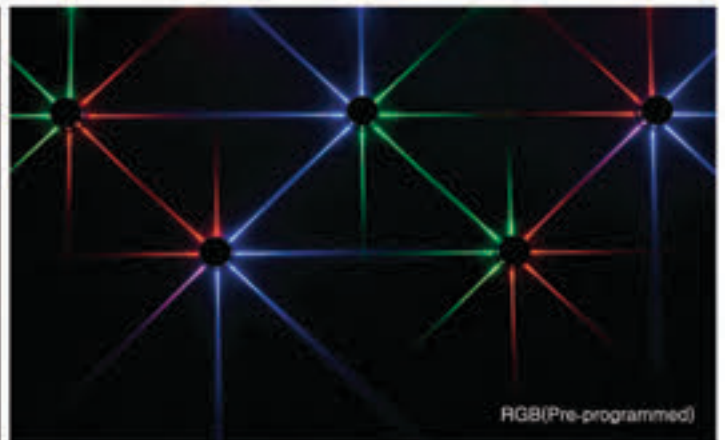
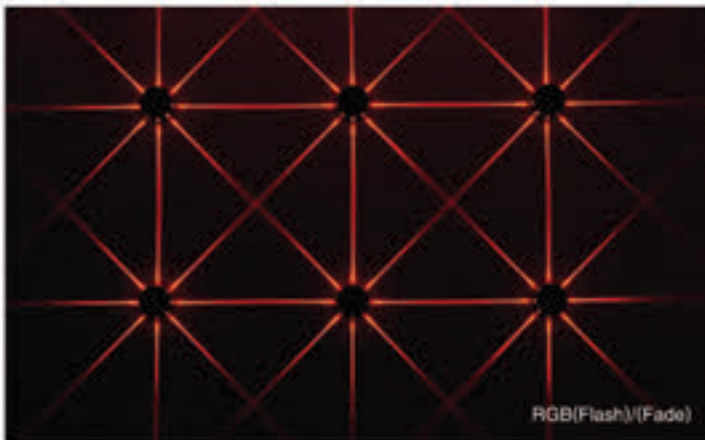



PRODUCTS CHARACTERS:

- Body: Made of high quality die-cast aluminum with treatment of corrosion protection and UV-proof powder coating.
- Diffuser: PMMA.
- Gasketing: Made of thermostable silica gel to improve protection class.
- Fastener: Made of stainless steel with high intensity and corrosion protection.
- Application: Facade lighting, wall of buildings, villas, parks, gardens, hotels and so on.
- Finish: Matt black as standard. Matt red, Matt coffee, Matt grey, Dark grey, Dark bronze any other RAL color is available upon request.

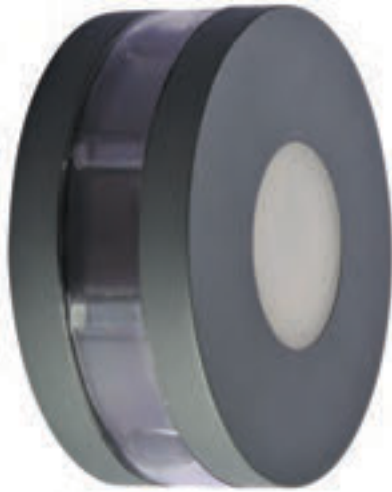
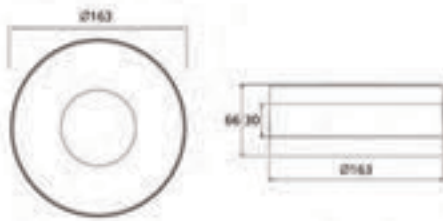

OLO-DHL-1317(R)				Single Color
● Red	LED	1Wx9	90-260V	50/60Hz

OLO-DHL-1317(G)				Single Color
● Green	LED	1Wx9	90-260V	50/60Hz

OLO-DHL-1317(B)				Single Color
● Blue	LED	1Wx9	90-260V	50/60Hz

OLO-DHL-1317(Y)				Single Color
● Yellow	LED	1Wx9	90-260V	50/60Hz

OLO-DHL-1317(WW)				Single Color
● Warm White	LED	1Wx9	90-260V	50/60Hz

OLO-DHL-1317(W)				Single Color
○ White	LED	1Wx9	90-260V	50/60Hz



LED Wall Light

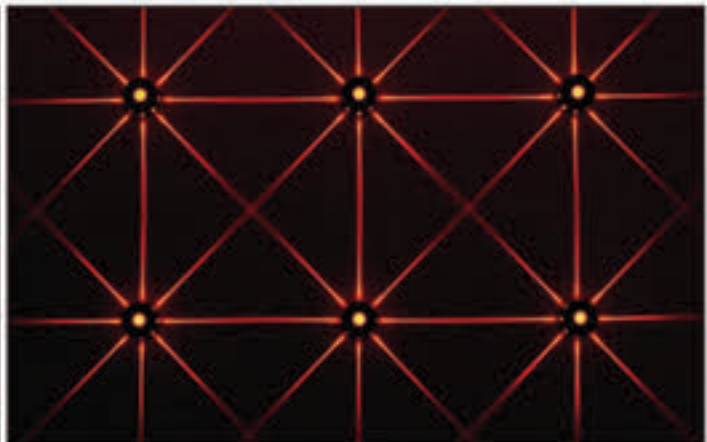
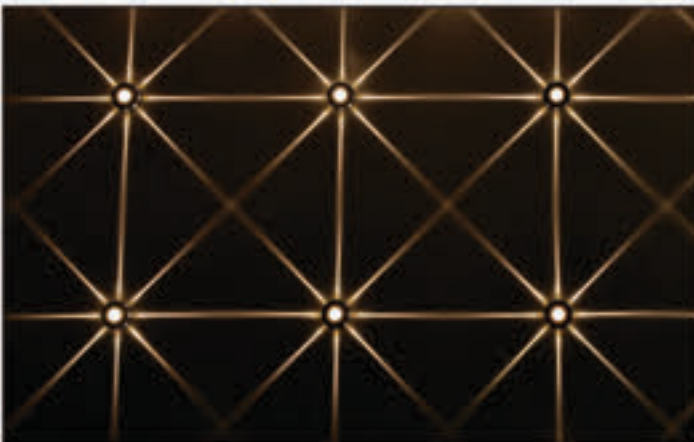
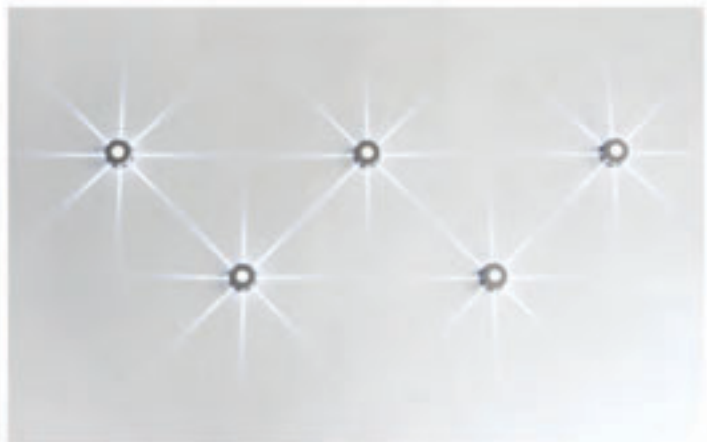



PRODUCTS CHARACTERS:

- Body: Made of high quality die-cast aluminum with treatment of corrosion protection and UV-proof powder coating.
- Diffuser: PMMA.
- Gasketing: Made of thermostable silica gel to improve protection class.
- Fastener: Made of stainless steel with high intensity and corrosion protection.
- Application: Facade lighting, wall of buildings, villas, parks, gardens, hotels and so on.
- Finish: Matt grey as standard. Matt red, Matt coffee, Matt black, Dark grey, Dark bronze any other RAL color is available upon request.

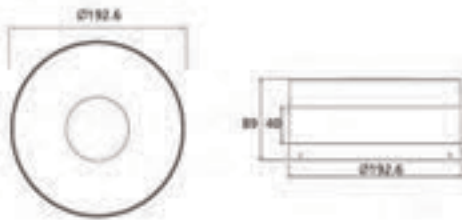

OLO-DHL-1318					RGB(Flash)
RGB	LED	9W	175-250V	50/60Hz	

OLO-DHL-1319					RGB(Fade)
RGB	LED	9W	175-250V	50/60Hz	

OLO-DHL-1320					RGB(Pre-programmed)
RGB	LED	25W	90-260V	50/60Hz	

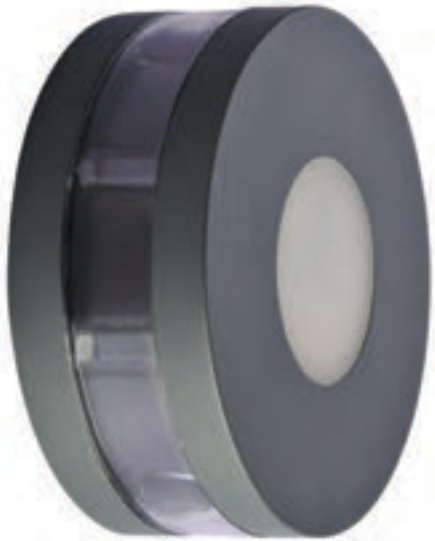

LED Wall Light

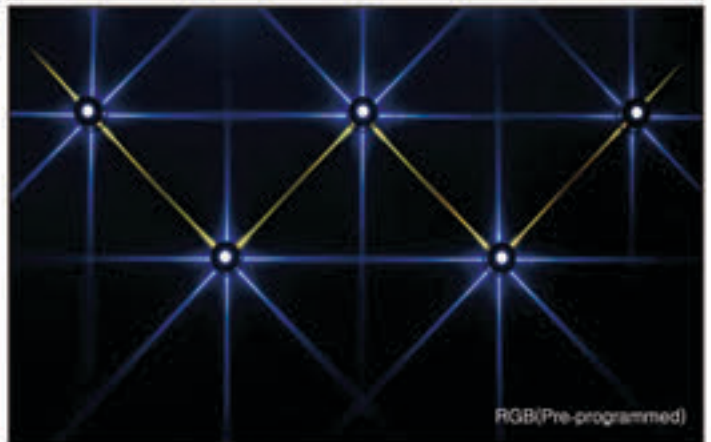
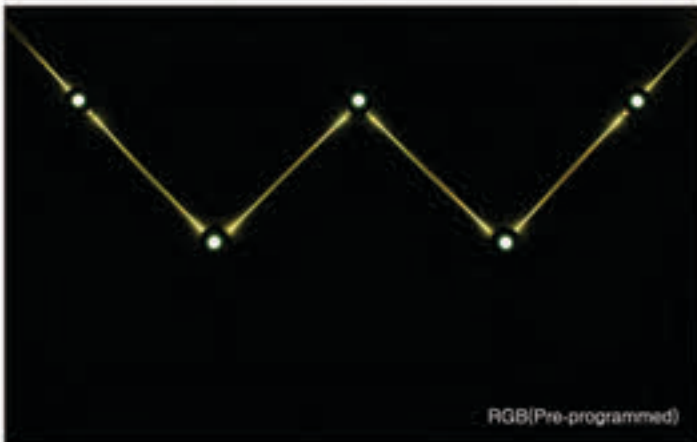
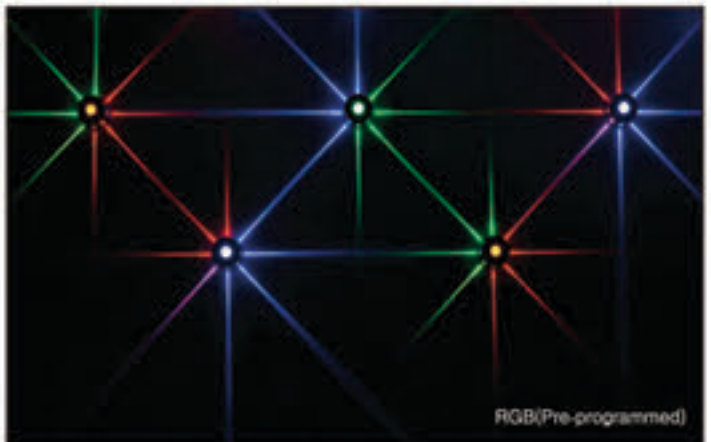
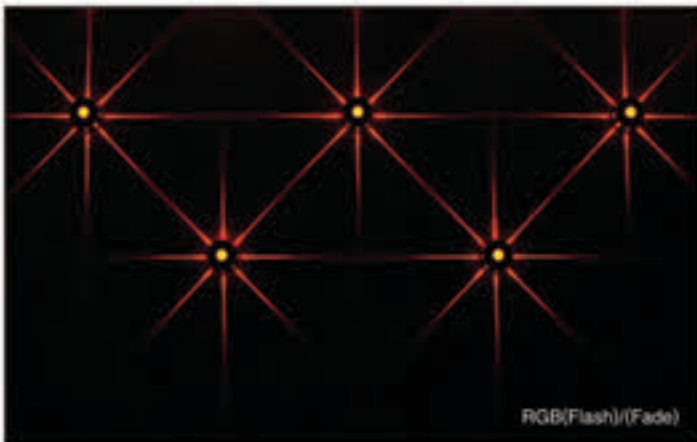



OLO-DHL-1671

Item No.	A	B	C	Lamp
OLO-DHL-1671	∅113	110	164	LED COB 10Wx1

- Cast aluminum body
- Clear glass
- 3000/6000K 90-260V 50/60Hz





OLO-DHL-1672

Item No.	A	B	C	Lamp
OLO-DHL-1672	Ø113	210	164	LED COB 10Wx2

- Cast aluminum body
- Clear glass
- 3000/6000K 90-260V 50/60Hz





OLO-DHL-1321



OLO-DHL-1322

Item No.	A	B	C	Lamp
OLO-DHL-1321	85	140	74	LED 1Wx2
OLO-DHL-1322	57	87	47	LED 1Wx1

- Cast aluminum body
- PMMA
- 3000/6000K 90-260V 50/60Hz

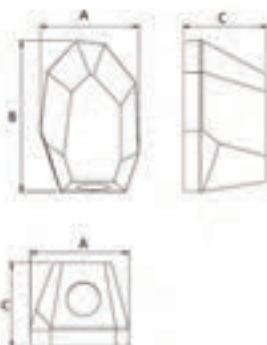
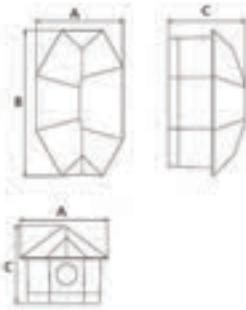



OLO-DHL-1323



OLO-DHL-1324

Item No.	A	B	C	Lamp
OLO-DHL-1323	160	85	160	LED 1Wx8
OLO-DHL-1324	125	70	125	LED 1Wx4

- Cast aluminum body
- PMMA
- 3000/6000K 90-260V 50/60Hz

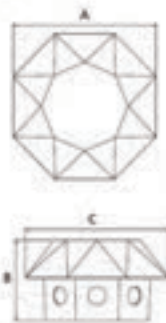

LED Wall Light





OLO-DHL-1325



OLO-DHL-1326

Item No.	A	B	C	Lamp
OLO-DHL-1325	105	105	50	LED 1Wx1
OLO-DHL-1326	105	105	45	LED 1Wx2

- Cast aluminum body
- PMMA
- 3000/6000K 90-260V 50/60Hz





OLO-DHL-1327



OLO-DHL-1328



OLO-DHL-1329

Item No.	A	B	C	Lamp
OLO-DHL-1327	120	125	53	LED 1Wx2
OLO-DHL-1328	105	105	45	LED 1Wx1
OLO-DHL-1329	109.5	109.5	67	LED 1Wx2

- Cast aluminum body
- PMMA
- 3000/6000K 90-260V 50/60Hz

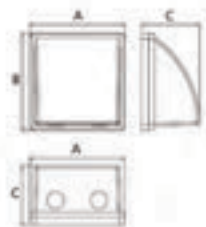
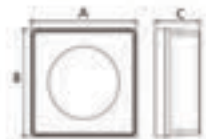
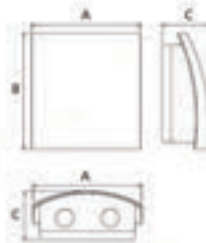



OLO-DHL-1330

Item No.	A	B	C	Lamp
OLO-DHL-1330	110	121	67	LED 1Wx1
OLO-DHL-1331	110	121	67	LED 1Wx1

- Cast aluminum body
- PMMA
- 3000/6000K 90-260V 50/60Hz

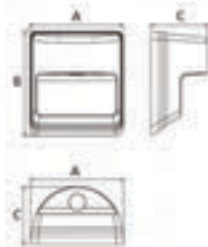

OLO-DHL-1331

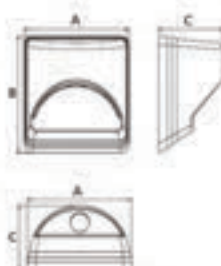



OLO-DHL-1332

Item No.	A	B	C	Lamp
OLO-DHL-1332	105	105	92	LED 1Wx4
OLO-DHL-1333	109.5	109.5	94	LED 1Wx2

- Cast aluminum body
- PMMA
- 3000/6000K 90-260V 50/60Hz



LED Wall Light



OLO-DHL-1333

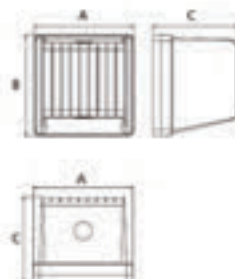



OLO-DHL-1334



OLO-DHL-1335

Item No.	A	B	C	Lamp
OLO-DHL-1334	123	114	Ø92	LED 3Wx2
OLO-DHL-1335	123	89	Ø92	LED 3Wx1

- Cast aluminum body
- Clear glass
- 3000/6000K 90-260V 50/60Hz

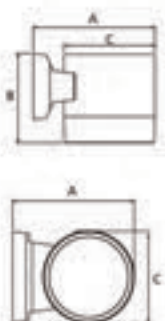
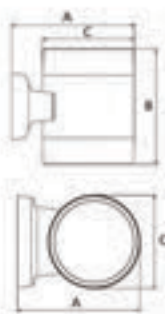



OLO-DHL-1336



OLO-DHL-1337

Item No.	A	B	C	Lamp
OLO-DHL-1336	141	103	□88	LED 3Wx2
OLO-DHL-1337	141	89	□88	LED 3Wx1

- Cast aluminum body
- Clear glass
- 3000/6000K 90-260V 50/60Hz

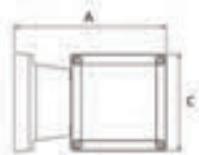
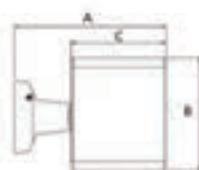

LED Wall Light

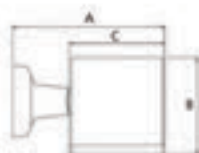



OLO-DHL-1401



OLO-DHL-1402

Item No.	A	B	C	Lamp
OLO-DHL-1401	□50	160	100	LED 3Wx1
OLO-DHL-1402	□50	250	LED 3Wx1	

- Cast aluminum body
- PMMA
- 3000/6000K 90-260V 50/60Hz





OLO-DHL-1403

Item No.	A	B	C	Lamp
OLO-DHL-1403	□50	105	100	LED 3Wx1
OLO-DHL-1404	□50	148	100	LED 3Wx2

- Cast aluminum body
- PMMA
- 3000/6000K 90-260V 50/60Hz



LED Wall Light



OLO-DHL-1404





OLO-DHL-1405



OLO-DHL-1406



OLO-DHL-1407

Item No.	A	B	C	Lamp
OLO-DHL-1405	∅92	121	124	LED 3Wx1
OLO-DHL-1406	∅60	107	106	LED 3Wx1
OLO-DHL-1407	∅60	130	106	LED 3Wx2

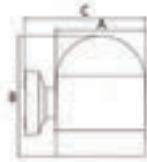

- Cast aluminum body
- Clear glass
- 3000/6000K 90-260V 50/60Hz

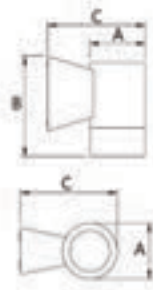



OLO-DHL-1408



OLO-DHL-1409



OLO-DHL-1410

Item No.	A	B	C	Lamp
OLO-DHL-1408	∅92	190	123	LED 3Wx1
OLO-DHL-1409	∅92	206	123	LED 3Wx1
OLO-DHL-1410	∅92	229	123	LED 3Wx1

- Cast aluminum body
- PMMA
- 3000/6000K 90-260V 50/60Hz

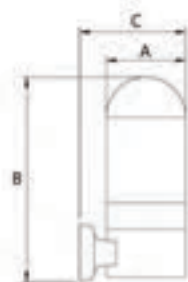
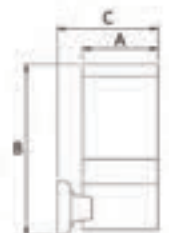



OLO-DHL-1411



OLO-DHL-1412



OLO-DHL-1413

Item No.	A	B	C	Lamp
OLO-DHL-1411	∅60	168	106	LED 3Wx1
OLO-DHL-1412	∅60	178	106	LED 3Wx1
OLO-DHL-1413	∅60	200	106	LED 3Wx1



- Cast aluminum body
- PMMA
- 3000/6000K 90-260V 50/60Hz





OLO-DHL-1414



OLO-DHL-1415



OLO-DHL-1416

Item No.	A	B	C	Lamp
OLO-DHL-1414	∅60	225	106	LED 3Wx1
OLO-DHL-1415	∅60	237	106	LED 3Wx1
OLO-DHL-1416	∅60	259	106	LED 3Wx1



- Cast aluminum body
- PMMA
- 3000/6000K 90-260V 50/60Hz



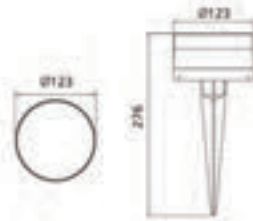

OLO-DHL-1493-2D				Single Color
●●●●○○	LED	1Wx2	90-260V	50/60Hz

OLO-DHL-1493-3D				Single Color
●●●●○○	LED	1Wx3	90-260V	50/60Hz

OLO-DHL-1493-4D				Single Color
●●●●○○	LED	1Wx4	90-260V	50/60Hz

LED Spike Light

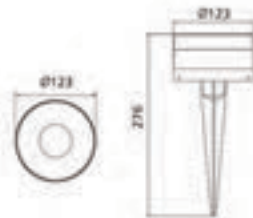

OLO-DHL-1494-2D				Single Color
●●●●○○	LED	1Wx3	90-260V	50/60Hz

OLO-DHL-1494-3D				Single Color
●●●●○○	LED	1Wx4	90-260V	50/60Hz

OLO-DHL-1494-4D				Single Color
●●●●○○	LED	1Wx5	90-260V	50/60Hz

- Cast aluminum body
- PMMA

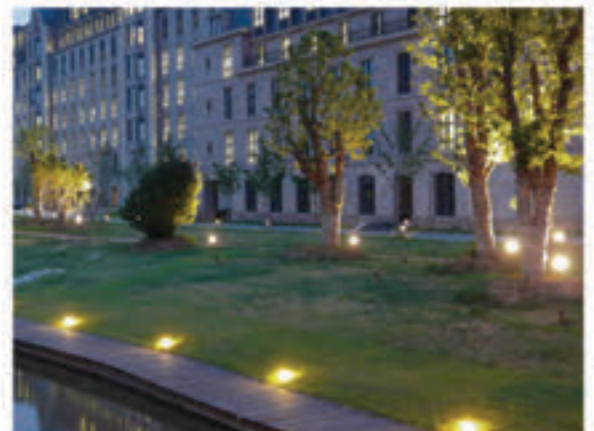

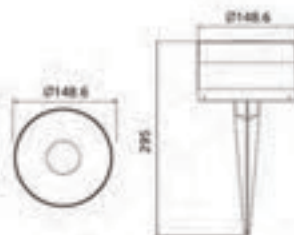
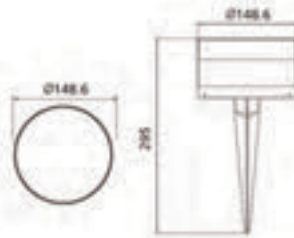

- Cast aluminum body
- PMMA



OLO-DHL-1493-2T					RGB(Flash)
RGB	LED	2W	175-250V	5Q/60Hz	
OLO-DHL-1493-2J					RGB(Fade)
RGB	LED	2W	175-250V	5Q/60Hz	
OLO-DHL-1493-2C					RGB(Pre-programmed)
RGB	LED	6W	90-260V	5Q/60Hz	
OLO-DHL-1493-3T					RGB(Flash)
RGB	LED	3W	175-250V	5Q/60Hz	
OLO-DHL-1493-3J					RGB(Fade)
RGB	LED	3W	175-250V	5Q/60Hz	
OLO-DHL-1493-3C					RGB(Pre-programmed)
RGB	LED	9W	90-260V	5Q/60Hz	
OLO-DHL-1495T					RGB(Flash)
RGB	LED	4W	175-250V	5Q/60Hz	
OLO-DHL-1495J					RGB(Fade)
RGB	LED	4W	175-250V	5Q/60Hz	
OLO-DHL-1495C					RGB(Pre-programmed)
RGB	LED	12W	90-260V	5Q/60Hz	

OLO-DHL-1494-2T					RGB(Flash)
RGB	LED	3W	175-250V	5Q/60Hz	
OLO-DHL-1494-2J					RGB(Fade)
RGB	LED	3W	175-250V	5Q/60Hz	
OLO-DHL-1494-2C					RGB(Pre-programmed)
RGB	LED	7W	90-260V	5Q/60Hz	
OLO-DHL-1494-3T					RGB(Flash)
RGB	LED	4W	175-250V	5Q/60Hz	
OLO-DHL-1494-3J					RGB(Fade)
RGB	LED	4W	175-250V	5Q/60Hz	
OLO-DHL-1494-3C					RGB(Pre-programmed)
RGB	LED	10W	90-260V	5Q/60Hz	
OLO-DHL-1496T					RGB(Flash)
RGB	LED	5W	175-250V	5Q/60Hz	
OLO-DHL-1496J					RGB(Fade)
RGB	LED	5W	175-250V	5Q/60Hz	
OLO-DHL-1496C					RGB(Pre-programmed)
RGB	LED	13W	90-260V	5Q/60Hz	





OLO-DHL-1497 Single Color

LED 1Wx8 90-260V 50-60Hz

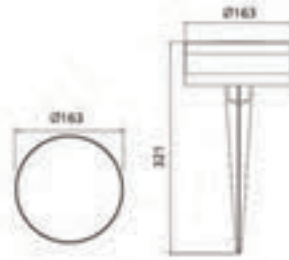

OLO-DHL-1498 Single Color

LED 1Wx9 90-260V 50-60Hz

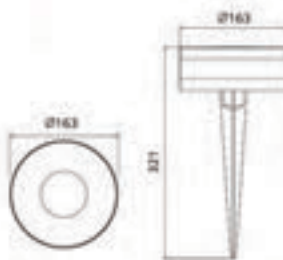

LED Spike Light

- Cast aluminum body
- PMMA



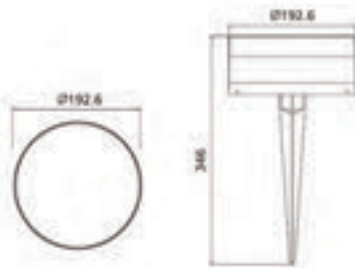

OLO-DHL-1499T				RGB(Flash)
RGB	LED	8W	175-250V	50/60Hz

OLO-DHL-1499J				RGB(Fade)
RGB	LED	8W	175-250V	50/60Hz

OLO-DHL-1499C				RGB(Pre-programmed)
RGB	LED	24W	90-260V	50/60Hz

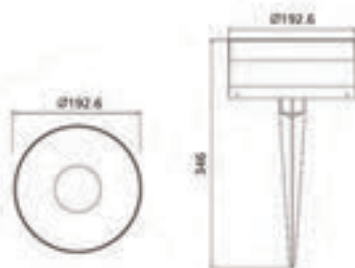

OLO-DHL-1500T				RGB(Flash)
RGB	LED	9W	175-250V	50/60Hz

OLO-DHL-1500J				RGB(Fade)
RGB	LED	9W	175-250V	50/60Hz

OLO-DHL-1500C				RGB(Pre-programmed)
RGB	LED	25W	90-260V	50/60Hz

- Cast aluminum body
- PMMA



LED Spike Light

50-200W NARROW BEAM LIGHT

LED Flood Light



OLO-DH-C04200



OLO-DH-C0450



OLO-DH-C04100



OLO-DH-C04150

Item No.	Power	Beam Angle	Size (mm)
OLO-DH-C0450	COB 50W	90°	285x275x66
OLO-DH-C04100	COB 100W	90°	293x293x90
OLO-DH-C04150	COB 150W	90°	336x317x95
OLO-DH-C04200	COB 200W	90°	375x375x121

- Cast aluminum body
- Clear glass



OLO-DH-C2030



OLO-DH-C2050



OLO-DH-C20100



OLO-DH-C20150

Item No.	Power	Beam Angle	Size (mm)
OLO-DH-C2030	COB 30W	120°	200x20x45
OLO-DH-C2050	COB 50W	120°	240x230x55
OLO-DH-C20100	COB 100W	120°	340x330x70
OLO-DH-C20150	COB 150W	120°	420x420x80

- Cast aluminum body
- Clear glass

10-150W WIDE BEAM LIGHT



OLO-DH-S2050

Item No.	Power	Beam Angle	Size (mm)
OLO-DH-S2010	SMD5730 10W	120°	145x145x35
OLO-DH-S2030	SMD5730 30W	120°	200x200x45
OLO-DH-S2050	SMD5730 50W	120°	240x230x55
OLO-DH-S20100	SMD5730 100W	120°	340x330x70
OLO-DH-S20150	SMD5730 150W	120°	420x420x80

- Cast aluminum body
- Clear glass



OLO-DH-S0650

Item No.	Power	Beam Angle	Size (mm)
OLO-DH-S0610	SMD2835 10W	120°	131x112x45
OLO-DH-S0620	SMD2835 20W	120°	175.5x156.5x54
OLO-DH-S0630	SMD2835 30W	120°	192x172x53.5
OLO-DH-S0650	SMD2835 50W	120°	236x202x69.2
OLO-DH-S0670	SMD2835 70W	120°	236x202x69.3
OLO-DH-S06100	SMD2835 100W	120°	272x252x82.8
OLO-DH-S06150	SMD2835 150W	120°	318x276x79.6
OLO-DH-S06200	SMD2835 200W	120°	383x322x81.6

- Cast aluminum body
- Clear glass



OLO-DH-S07100



OLO-DH-S0720



OLO-DH-S0730



OLO-DH-S0750

Item No.	Power	Beam Angle	Size (mm)
OLO-DH-S0720	SMD3030 20W	8° /15° /35°	180x165x40
OLO-DH-S0730	SMD3030 30W	8° /15° /35°	225x200x45
OLO-DH-S0750	SMD3030 50W	8° /15° /35°	230x240x45
OLO-DH-S07100	SMD3030 100W	8° /15° /35°	285x350x45

- Cast aluminum body
- Clear glass



OLO-DH-S0850



OLO-DH-S0810



OLO-DH-S0820



OLO-DH-S0830

Item No.	Power	Beam Angle	Size (mm)
OLO-DH-S0810	SMD3030 10W	8° /15° /35°	135x115x25
OLO-DH-S0820	SMD3030 20W	8° /15° /35°	176x151.5x25
OLO-DH-S0830	SMD3030 30W	8° /15° /35°	203.5x179x30
OLO-DH-S0850	SMD3030 50W	8° /15° /35°	223x214.5x37.5

- Cast aluminum body
- Clear glass

50-200W WIDE BEAM LIGHT



OLO-DH-C1930



OLO-DH-C1910



OLO-DH-C1920

Item No.	Power	Beam Angle	Size (mm)
OLO-DH-C1910	COB 10W	120°	131x112x45
OLO-DH-C1920	COB 20W	120°	175.5x156.5x54
OLO-DH-C1930	COB 30W	120°	192x172x53.5

- Cast aluminum body
- Clear glass

10-30W WIDE BEAM LIGHT



OLO-DH-C19150
OLO-DH-C19200



OLO-DH-C1950



OLO-DH-C19100

LED Flood Light

Item No.	Power	Beam Angle	Size (mm)
OLO-DH-C1950	COB 50W	120°	236x202x69.2
OLO-DH-C19100	COB 100W	120°	272x252x82.8
OLO-DH-C19150	COB 150W	120°	318x276x79.6
OLO-DH-C19200	COB 200W	120°	383x322x81.6

- Cast aluminum body
- Clear glass

Led wall washer
OLO-5380



Specification

Model	OLO-5380
Dimension	1000x53x80mm
Single Power	24W/48W
Input Voltage	DC24V
Protecting Grade	IP65
Color	WW, W, RGB
Life	50000H
Working temperature	-45°C - 55°C
Beam Angle	15° 30° 45° 60°
Light Source	CREE/EVERLIGHT/EPSTAR
Material	Aluminum body, toughened glasscover
Lumens Depreciation	3000 WORKING HOURS <3% , 3000 WORKING HOURS <5%

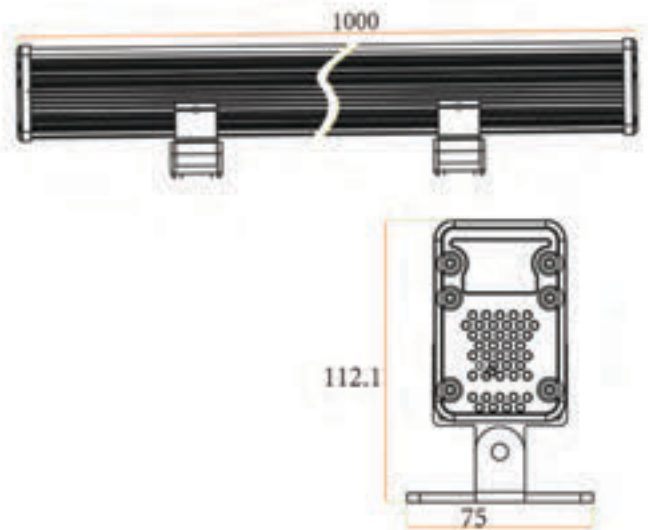

Application



Suitable: Landscape lighting, bridges, billboards, subway, high-speed rail station

Led wall washer
OLO-4591



Specification

Model	OLO-4591
Dimension	1000x45x91mm
Single Power	24W/36W
Input Voltage	DC24V
Protecting Grade	IP65
Color	WW, W, RGB
Life	50000H
Working temperature	-45°C ~ 55°C
Beam Angle	15° 30° 45° 60°
Light Source	CREE/EVERLIGHT/EPISTAR
Material	Aluminum body, toughened glass cover
Lumens Depreciation	1000 WORKING HOURS <3% , 3000 WORKING HOURS <5%

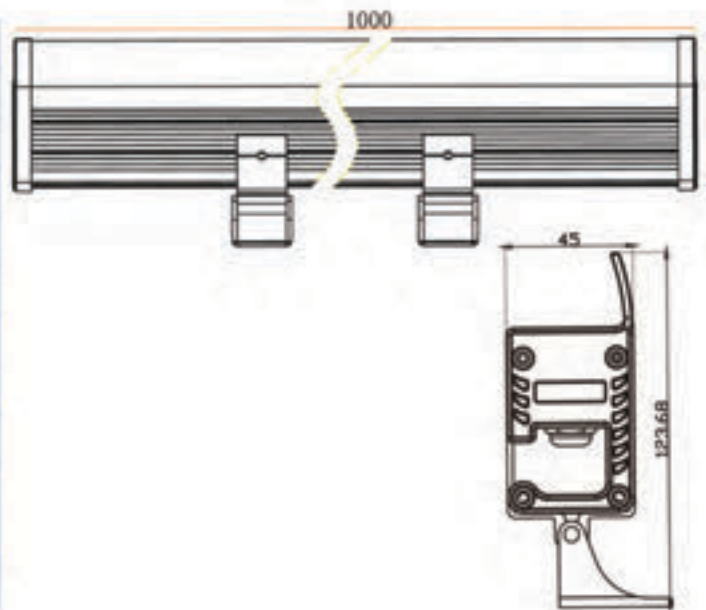

Application

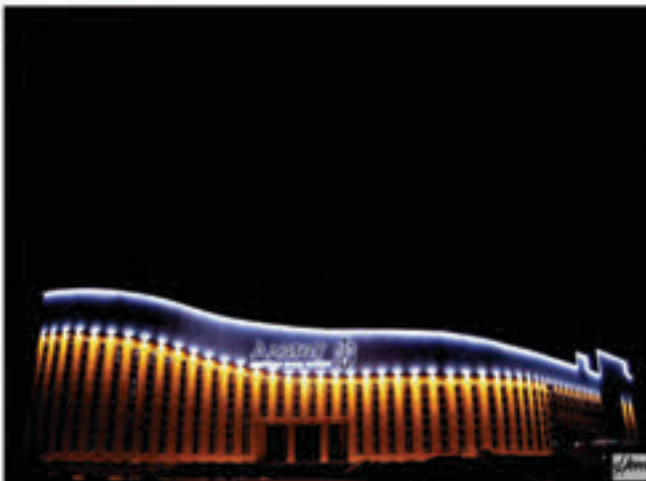

Suitable: Landscape lighting, bridges, billboards, subway, high-speed rail station

Led wall washer
OLO-41-36



Specification

Model	OLO-41-36
Dimension	1000x41.5x91mm
Single Power	18-36W
Input Voltage	AC220V / DC24V / AC24V
Protecting Grade	IP65
Color	WW, W, RGB
Life	50000H
Working temperature	-45°C - 55°C
Beam Angle	15° 25° 30° 45° 60°
Light Source	CREE/EVERLIGHT/EPSTAR
Material	Aluminum body, toughened glasscover
Lumens Depreciation	3000 WORKING HOURS <3% , 3000 WORKING HOURS <5%

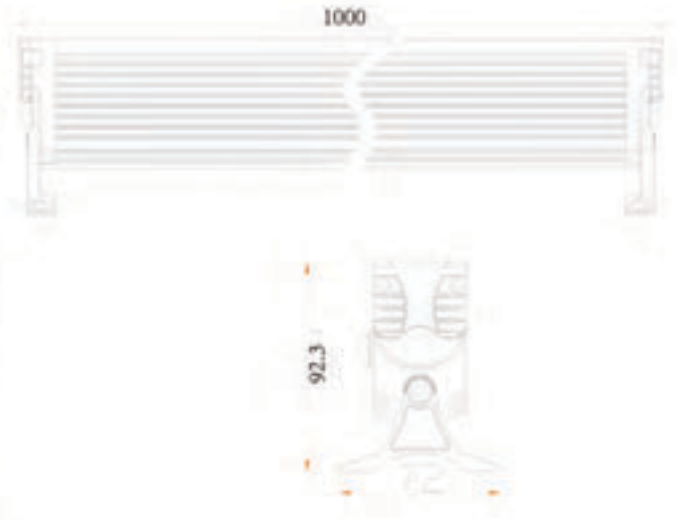

Application



Suitable: Landscape lighting, bridges, billboards, subway, high-speed rail station

Led wall washer
OLO-3037



Specification

Model	OLO-3037
Dimension	1000x30x37mm
Single Power	24W
Input Voltage	DC24V
Protecting Grade	IP65
Color	WW, W, RGB
Life	50000H
Working temperature	-45°C - 55°C
Beam Angle	15° 30° 45° 60°
Light Source	CREE/EVERLIGHT/EPISTAR
Material	Aluminum body, toughened glasscover
Lumens Depreciation	1000 WORKING HOURS <3% , 3000 WORKING HOURS <5%

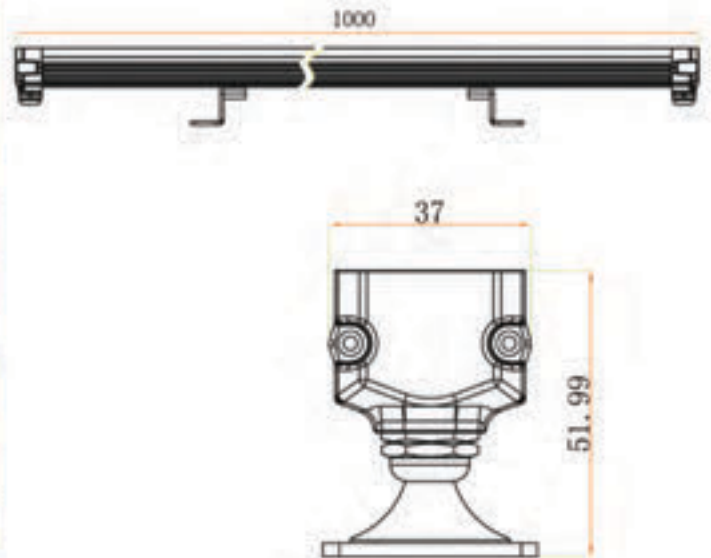

Application



Suitable: Landscape lighting, bridges, billboards, subway, high-speed rail station

Led smd lamp
OLO-95-16



Specification

Model	OLO-95-16
Dimension	1000x95x41mm
Single Power	16W
Input Voltage	DC24V
Protecting Grade	IP65
Color	RGB W
Life	50000H
Working temperature	-40°C ~ 55°C
Light Source	CREE/EVERLIGHT/EPSTAR
Material	Aluminum body,toughened glasscover
Lumens Depreciation	1000 WORKING HOURS <3% , 3000 WORKING HOURS <5%



Application

LED Wall Washer

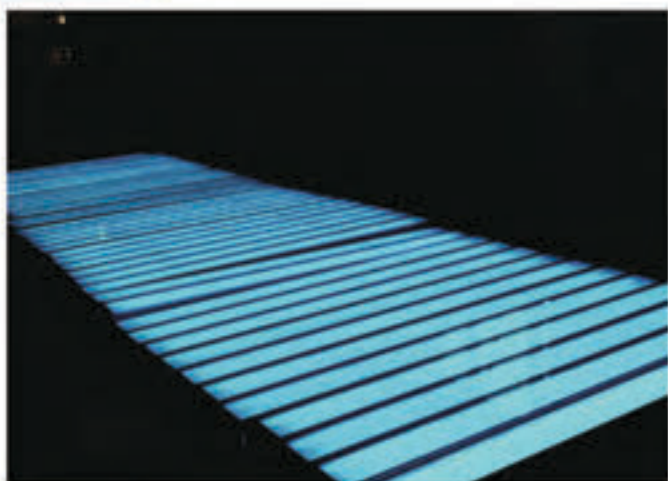

Suitable: Landscape lighting, bridges, billboards, subway, high-speed rail station

Led wall washer
OLO-750-216



Specification

Model	OLO-750-216
Dimension	755x290x270mm
Single Power	216W
Input Voltage	DC24V
Protecting Grade	IP65
Color	WW, W, RGB
Life	50000H
Working temperature	-45°C - 55°C
Beam Angle	15° 30° 45° 60°
Light Source	CREE/EVERLIGHT/EPISTAR
Material	Aluminum body, toughened glasscover
Lumens Depreciation	3000 WORKING HOURS <3%, 3000 WORKING HOURS <5%

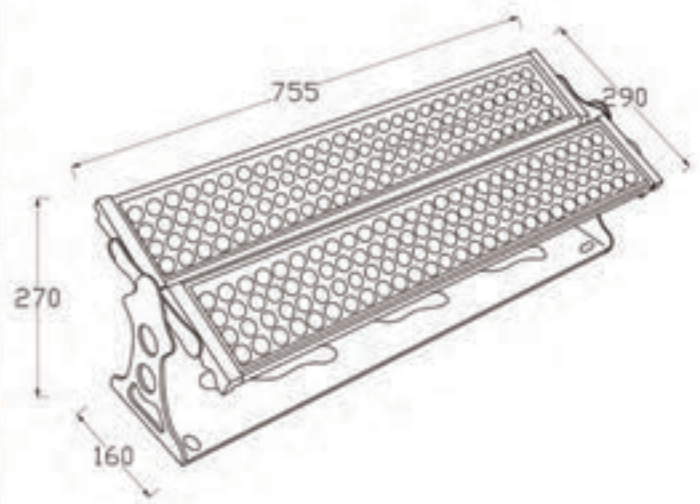

Application



Suitable: Landscape lighting, bridges, billboards, subway, high-speed rail station

Led guardrail tube
OLO-B35-48



Specification

Model	OLO-B35-48
Dimension	35x53x1000mm
Single Power	9-16W
Input Voltage	DC24V
Protecting Grade	IP65
Color	WW, W, RGB
Life	50000H
Working temperature	-45°C - 55°C
Beam Angle	120°
Light Source	CREE/EVERLIGHT/EPSTAR
Material	Aluminum base, anti-aging PC material
Lumens Depreciation	1000 WORKING HOURS <3% , 3000 WORKING HOURS <5%

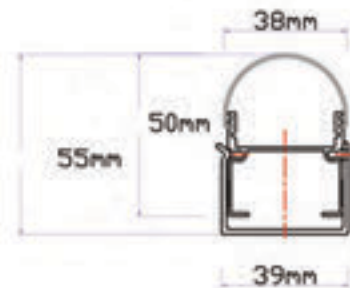

Application

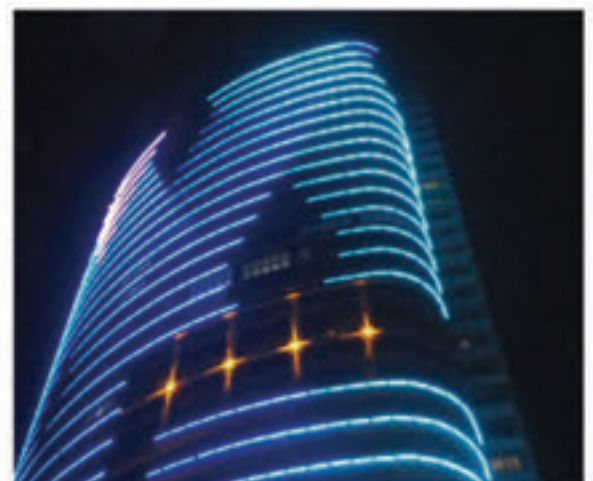
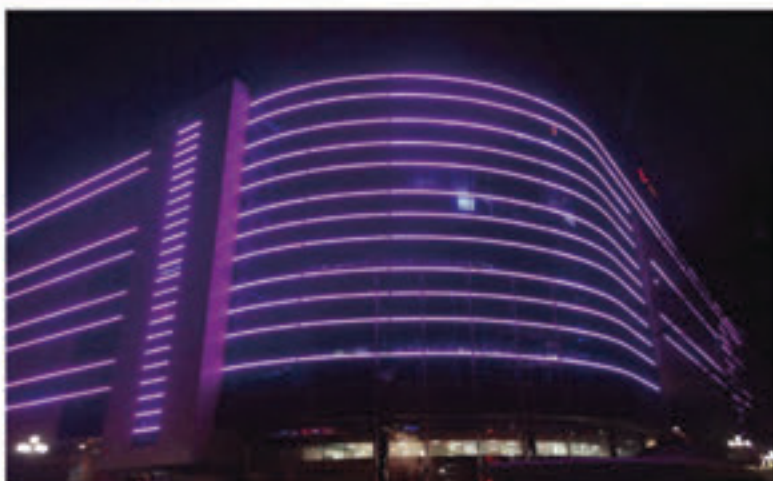

Suitable: Guardrail, bridge, building outline, street lighting, parks

Light guide plate
OLO-BD1535



Specification

Model	OLO-BD1535
Dimension	1500x15x35mm
Single Power	18W
Input Voltage	DC24V
Protecting Grade	IP65
Color	WW, W, RGB
Life	50000H
Working temperature	-45°C - 55°C
Beam Angle	180°
Light Source	CREE/EVERLIGHT/EPSTAR
Material	Aluminum body, smooth guide cover
Lumens Depreciation	1000 WORKING HOURS < 3% , 3000 WORKING HOURS < 5%

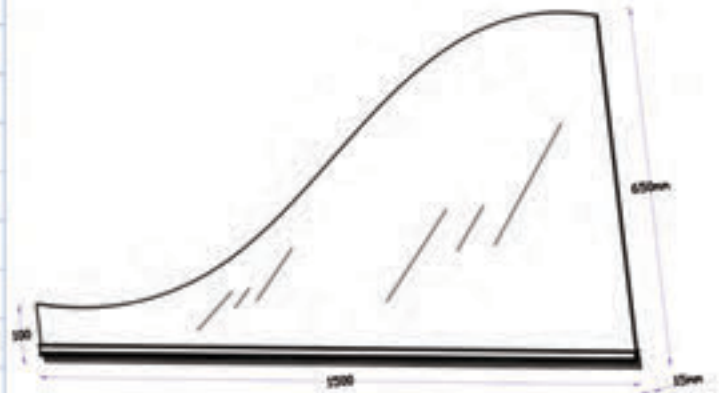

Application



Suitable: Landscape lighting, bridges, billboards, subway, high-speed rail station

LED Wall Washer

Led window light
OLO-CT6575



Specification

Model	OLT-CT6575
Dimension	200x65x75mm
Single Power	10W
Input Voltage	DC24V
Protecting Grade	IP65
Color	WW, W, RGB
Life	50000H
Working temperature	-45°C - 55°C
Beam Angle	15° 30° 45° 60°
Light Source	CREE/EVERLIGHT/EPSTAR
Material	Aluminum body,toughened glasscover
Lumens Depreciation	1000 WORKING HOURS <3% , 3000 WORKING HOURS <5%

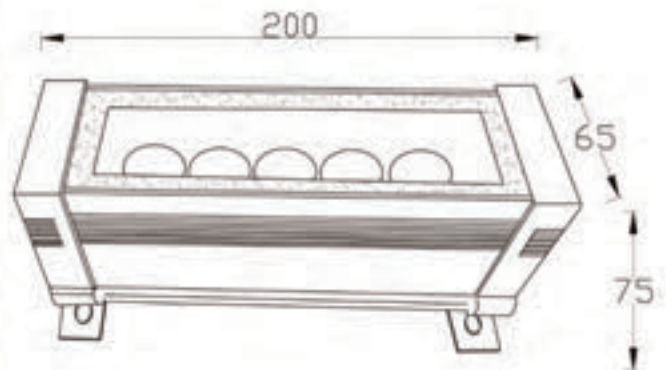

Application



Suitable: House of windows, walkways, corridors, garage doors, building outline lights

Led wall washer
OLO-XQ62-36



Specification

Model	OLO-XQ62-36
Dimension	66x37x1000mm
Single Power	36W
Input Voltage	DC24V
Protecting Grade	IP65
Color	WW, W, RGB
Life	50000H
Working temperature	-45°C ~ 55°C
Beam Angle	15° 30° 45° 60°
Light Source	CREE/EVERLIGHT/EPISTAR
Material	Aluminum body
Lumens Depreciation	1000 WORKING HOURS <3% , 3000 WORKING HOURS <5%



Application



LED Wall Washer

Suitable: Landscape lighting, bridges, billboards, subway, high-speed rail station

Led wall washer
OLO-XQ3034



Specification

Model	OLO-XQ3034
Dimension	1000x30x34mm
Single Power	15W
Input Voltage	DC24V
Protecting Grade	IP65
Color	WW, W, RGB
Life	50000H
Working temperature	-45°C ~ 55°C
Beam Angle	15°, 30°, 60°
Light Source	CREE/EVERLIGHT/EPSTAR
Material	Aluminum body, toughened glasscover
Lumens Depreciation	1000 WORKING HOURS <3% , 3000 WORKING HOURS <5%

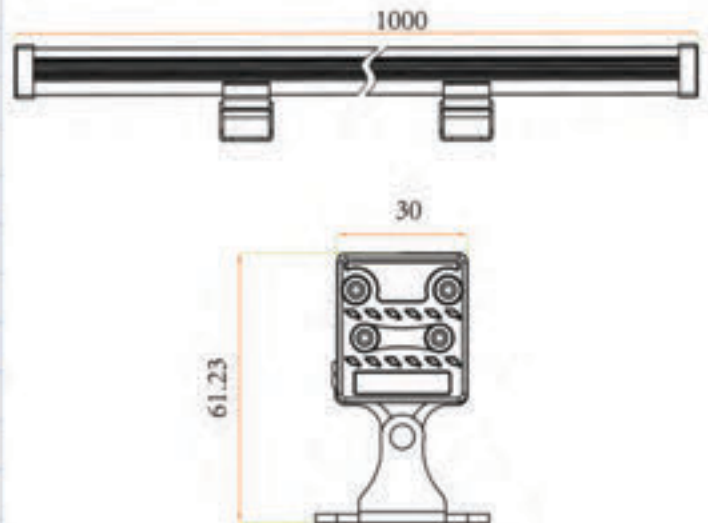

Application



Suitable: Landscape lighting, bridges, billboards, subway, high-speed rail station

Led wall washer
OLO-XT57-24



Specification

Model	OLO-XT57-24
Dimension	1000x40x56.5mm
Single Power	24W
Input Voltage	DC24V
Protecting Grade	IP65
Color	WW, W
Life	50000H
Working temperature	-45°C - 55°C
Beam Angle	15°, 30°, 60°
Light Source	CREE/EVERLIGHT/EPISTAR
Material	Aluminum body, toughened glasscover
Lumens Depreciation	1000 WORKING HOURS <3% , 3000 WORKING HOURS <5%



Application



Suitable: Landscape lighting, bridges, billboards, subway, high-speed rail station

Led projector
OLO-BD95-12



Specification

Model	OLO-BD95-12
Dimension	95x95x105mm
Single Power	12W
Input Voltage	DC24V
Protecting Grade	IP65
Color	RGBW
Life	50000H
Working temperature	-45°C~55°C
Beam Angle	8°, 15°, 30°
Light Source	CREE/EVERLIGHT/EPSTAR
Material	Aluminum body,toughened glasscover
Lumens Depreciation	1000 WORKING HOURS < 3% , 3000 WORKING HOURS < 5%

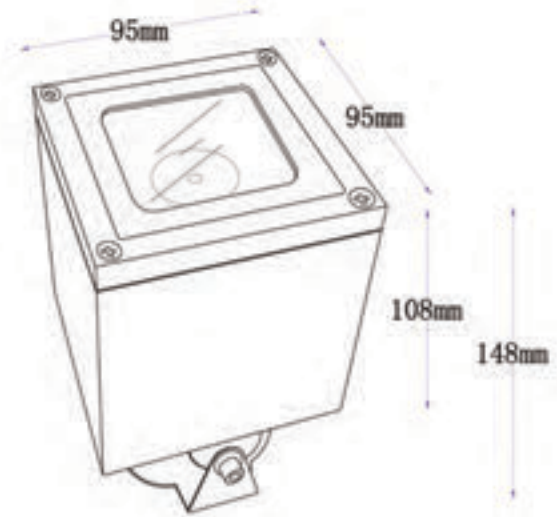

Application

LED Wall Washer

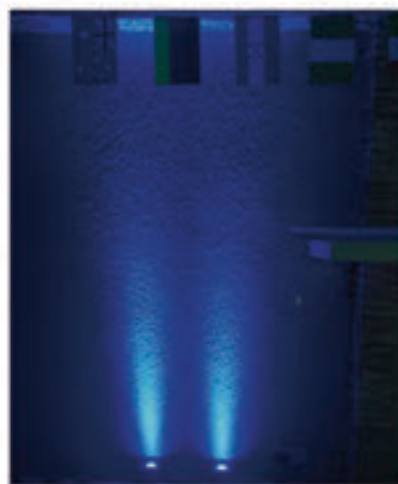
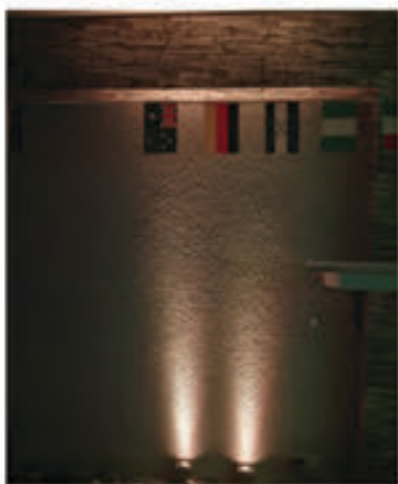

Suitable: Landscape lighting, bridges, billboards, subway, high-speed rail station

Led pixel lamp
OLO-XST33-4



Specification

Model	OLO-XST33-4
Dimension	Φ33*H11mm
Single Power	1W
Input Voltage	DC15V
Protecting Grade	IP65
Color	RGBW
Life	50000H
Working temperature	-45°C - 55°C
Beam Angle	120°
Light Source	CREE/EVERLIGHT/EPISTAR
Material	Zincalloy stainlesssteel body
Lumens Depreciation	1000 WORKING HOURS <3% , 3000 WORKING HOURS <5%

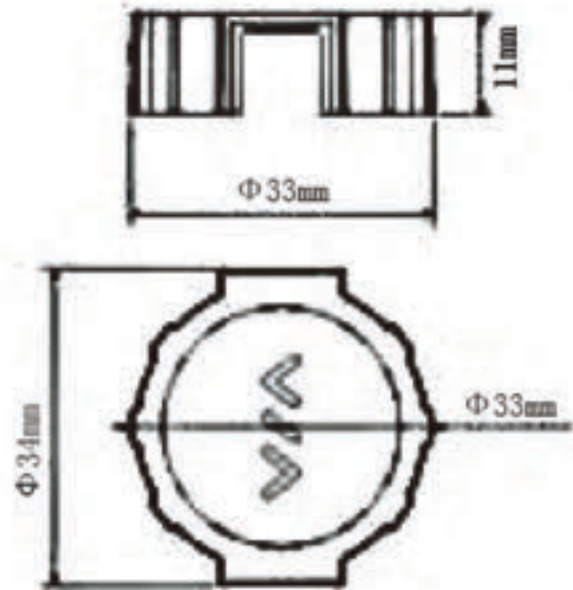

Application



Suitable: Landscape, bridge, building body, walls, hotels, billboardsstation

Led crystal pillar lamp
OLO-ZT150



Specification

Model	OLO-ZT150
Dimension	4150*180mm
Single Power	5W
Input Voltage	DC24V
Protecting Grade	IP65
Color	W, WW ,RGB
Life	50000H
Working temperature	-30°C - 55°C
Beam Angle	120°
Light Source	CREE/EVERLIGHT/EPSTAR
Material	Aluminum base,crystal cover
Lumens Depreciation	1000 WORKING HOURS <3% , 3000 WORKING HOURS <5%

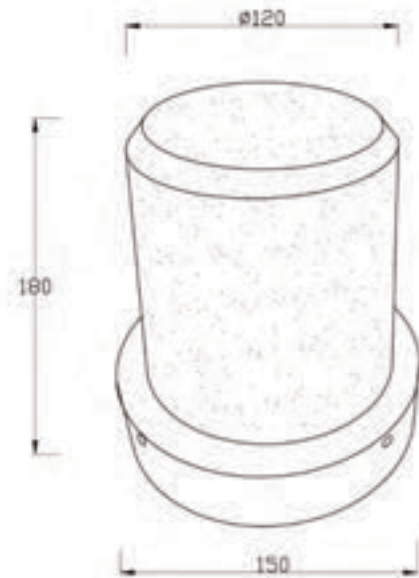

Application



Suitable: Squares, parks, bridges,, scenic, highway guardrail

Led projector
OLO-TG95-12

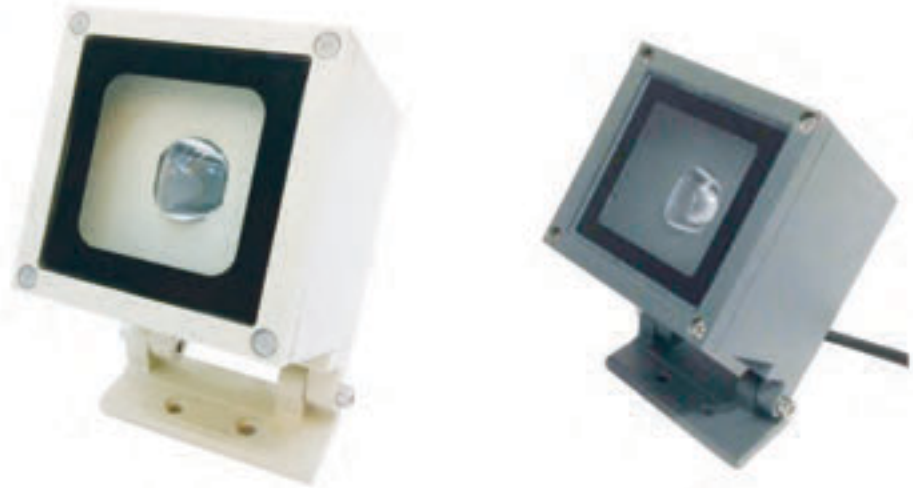

Specification

Model	OLO-TG95-12
Dimension	95x95x140mm
Single Power	12W
Input Voltage	DC24V
Protecting Grade	IP65
Color	W, WW
Life	50000H
Working temperature	-30°C ~ 55°C
Beam Angle	5X70°
Light Source	CREE/EVERLIGHT/EPISTAR
Material	Aluminum body, toughened glasscover
Lumens Depreciation	1000 WORKING HOURS <3% , 3000 WORKING HOURS <5%

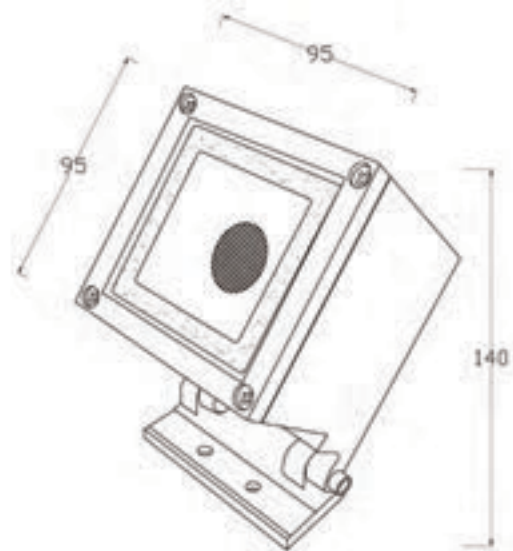

Application

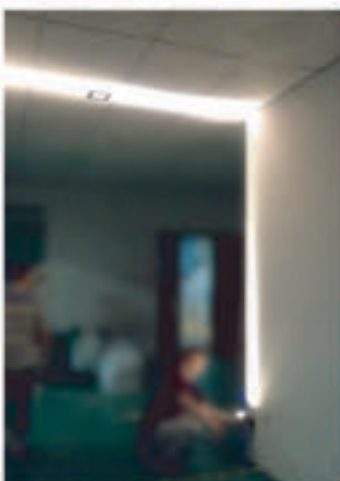

Suitable: Landscape lighting, bridges, billboards, subway, high-speed rail station

Led armrest lampr
OLO-FS5050

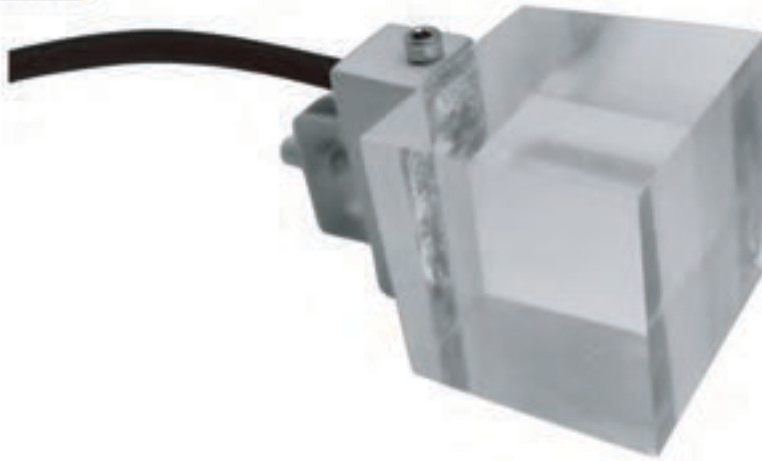

Specification

Model	OLO-FS5050
Dimension	50*50*70mm
Single Power	0.5W
Input Voltage	DC24V
Protecting Grade	IP65
Color	W, WW, RGB
Life	50000H
Working temperature	-30°C ~ 55°C
Beam Angle	120°
Light Source	CREE, EVERLIGHT, EPSTAR
Material	Aluminum body, crystal cover
Lumens Depreciation	1000 WORKING HOURS <3% , 3000 WORKING HOURS <5%

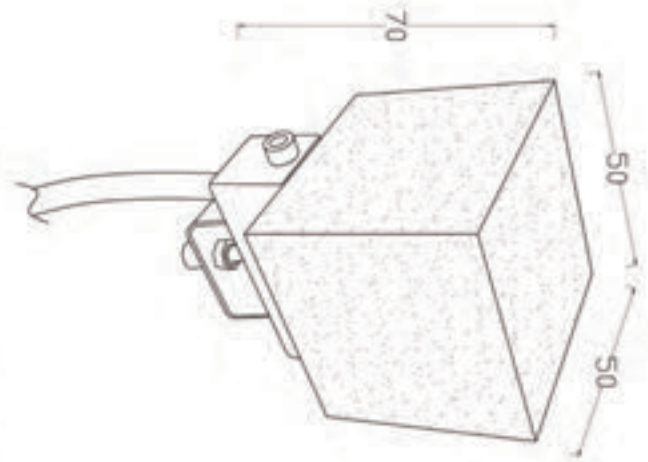

Application

LED Wall Washer

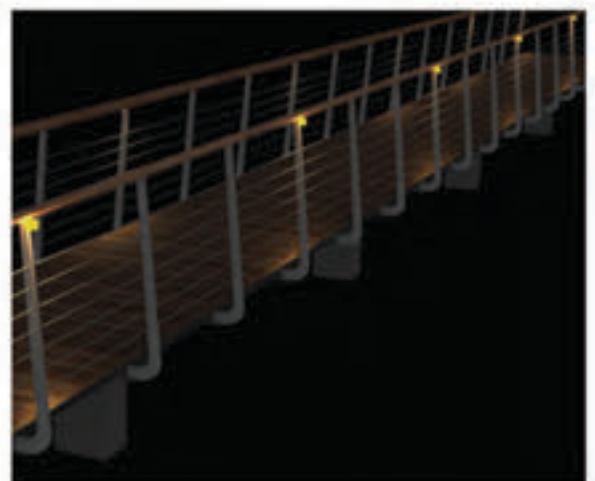
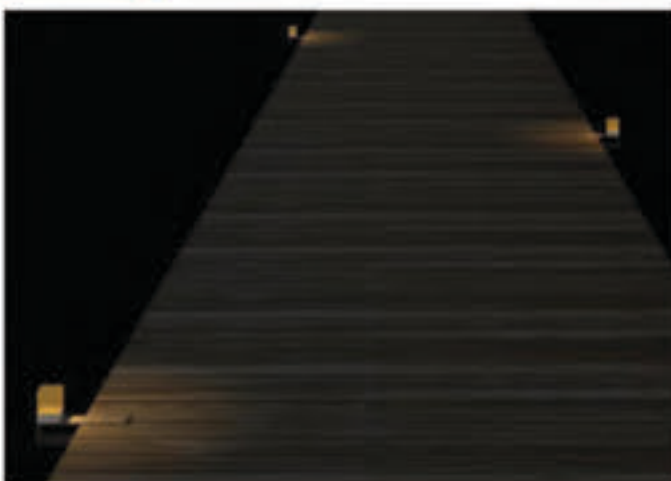

Suitable: Bridge parapet, scenic guardrail, highway guardrail

“OLYMP UNION”

